BuzziHood

Product Specification Sheet

This document contains technical information about the BuzziHood



www.buzzi.space

Wall mounted acoustic telephone booth

The BuzziHood works just like the BuzziBooth, providing an acoustic cocoon you can hang on the wall. When you're in the Hood' you can answer the phone in peace in noisy surroundings without ever having to ask anyone to repeat themselves. It can be installed anywhere and will cheer up any Space!

Design by Alian Gilles

General

 BuzziHood
Flat | 3D

Structure: poplar plywood

 Cover: CME35H foam + layer felt 3 mm | 0.12" covered with fabric
Fabrics: Fabric, Rough, Terra, Tartan (not suitable for 3D Rib), Trevira CS+ | CS, Revive 1, Revive 2, Clara 2, Remix 2, Hero, Tonus 4, Tonus Meadow, Memory 2 or Matrix

 L 71 cm W 89,5 cm H 107 cm
L 27.95 " W 35.24" H 42.13"

 ± 40 kg
± 88.18 lbs

Acoustics



Absorption



Attenuation

Content

Configurations	3
Patterns	4
Option tablet	4
Fabrics	5
Fixing system	9
Dimensions	10

Configurations

BuzziHood

🔪 Flat | 3D

Core: poplar plywood

Cover: CME35H foam + layer felt 0,3 cm | 0.12"

Covered with fabric

🌲 Fabrics: Fabric, Rough, Terra, Tartan (not suitable for 3D Rib),
Trevira CS+ | CS, Revive 1, Revive 2,
Clara 2, Remix 2, Hero, Tonus 4, Tonus Meadow, Memory 2 or
Matrix

✂ L 71 cm W 89,5 cm H 107 cm
L 27.95 " W 35.24" H 42.13"

⚖ ± 40 kg
± 88.18 lbs

⋯ Bicolor
Tablet in Oak or Metal

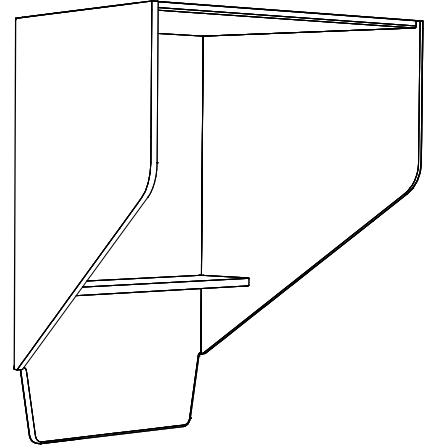

Patterns

Flat

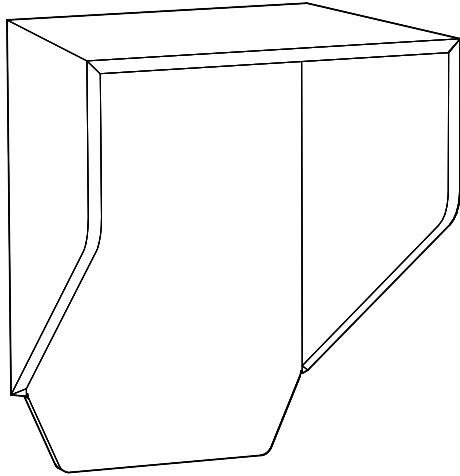

3D

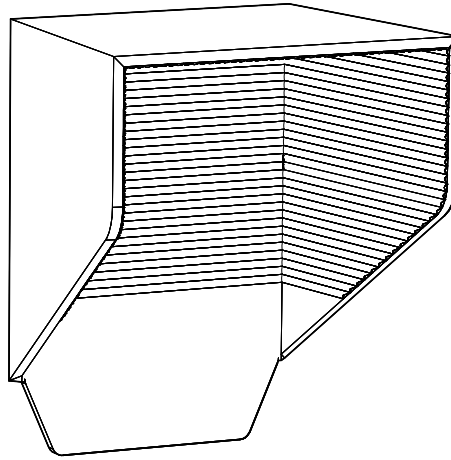

Option Tablet

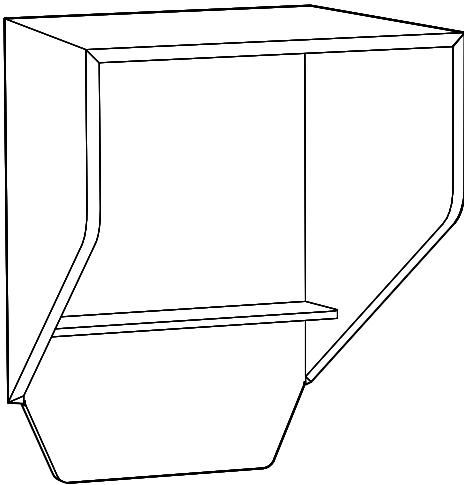

Tablet horizontal in wood

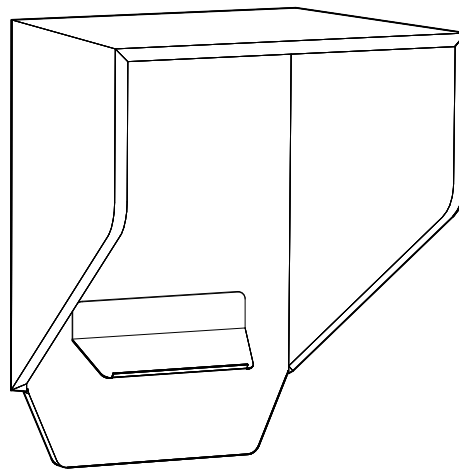

Tablet Inclined in powder coated metal

Finishes Tablet



Oak
(Tablet wood)

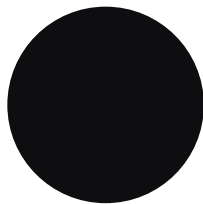

Black (RAL 9005)
(Tablet metal)



White (RAL 9010)
(Tablet metal)

Fabrics

Fabric

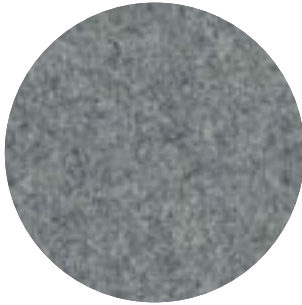

Category A

Composition 70% Recycled Wool, 25% Recycled Polyacryl,
5% Recycled Other Fabrics

Weight 405 g/m² | 11.94 oz/yd²

Abrasion resistance 40.000 Martindale, 50,000 Wyzenbeek

Flammability EU: EN 1021.1/2006 | BS EN 1021.1/2006 (cigarette),
EN 1021.2/2006 | BS EN 1021.2/2006 (match)
USA: CAL TB 117 | ASTM E84 CLASS A

Fastness to light EU: 4 | USA 4

Fastness to rubbing EU: Wet 3-4 | Dry 4-5

Fastness to crocking USA: Wet 5 | Dry 5



Rough

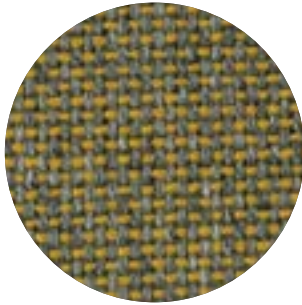

Category A

Composition 100% Polyacryl

Weight 456 g/m² | 13.45 oz/yd²

Abrasion resistance 40.000 Martindale

Flammability EU: EN 1021.1/2006 | BS EN 1021.1/2006 (cigarette)
USA: CAL TB TB 117

Fastness to light EU: 5

Fastness to rubbing EU: Wet: 3 | Dry: 3



Trevira CS+ | CS

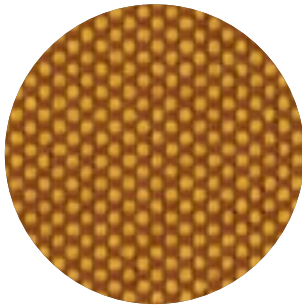

Category A

Weight 420 g/m² | 12.39 oz/yd²

Composition 100% Polyester, Trevira CS

Abrasion resistance 100.000 Martindale, 90,000 Wyzenbeek

Flammability BS 5852 part II: CRIB 5 | BS 7176 Medium Hazard
USA: CAL TB 117 | M1 | B1 | EN 1021/1-2 | C1 |
IMO Res. A652 (16)

Fastness to light EU: 6 | USA 5

Fastness to rubbing EU: Wet 4-5 | Dry 4-5

Fastness to crocking USA: Wet 5 | Dry 5



Revive 1

kvadrat

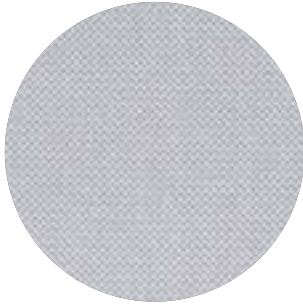

Category A

Composition 100% recycled polyester FR

Weight 430 g/lin.m

Abrasion resistance 60.000 Martindale rubs, EN ISO 12947

Flammability EN 1021-1/2 | DIN 4102 B1 | Önorm B1/Q1
UNI 9175 1IM | US Cal. Tech. Bull. 117
IMO A.652 (16)

Fastness to light Note 5-7, ISO 105-B02

Fastness to rubbing (ISO) dry 5, wet 4-5

Pilling Note 4-5, EN ISO 12945



Revive 2

kvadrat

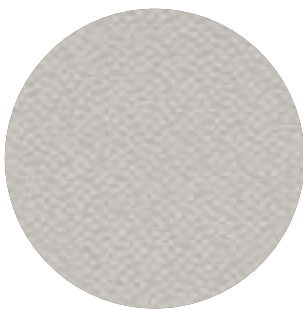

Category A

Composition 100% recycled polyester FR

Weight 420 g/lin.m

Abrasion resistance 45.000 Martindale rubs, EN ISO 12947

Flammability EN 1021-1/2 | DIN 4102 B1 | Önorm B1/Q1
UNI 9175 1IM | US Cal. Tech. Bull. 117
IMO A.652 (16)

Fastness to light Note 5-7, ISO 105-B02

Fastness to rubbing (ISO) dry 5, wet 4-5

Pilling Note 4-5, EN ISO 12945



Terra



Category B

Composition 100% Pure New Wool

Weight 370 g/m² | 10.91 oz/yd²

Abrasion resistance 40.000 Martindale, 25,000 Wyzenbeek

Flammability EU: BS5852 CRIB 5 | BS5867 PART 2 : 2008 : TYPE B
EN: 1021.2/2006 | USA: CAL TB 117

Fastness to light EU 5 | USA 5

Fastness to rubbing EU: Wet 4 | Dry 4

Fastness to crocking USA: Wet 4 | Dry 4



Clara 2

kvadrat

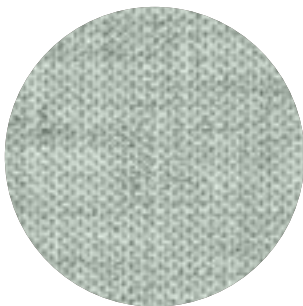

Category B

Composition 92% new wool, 8% nylon

Weight 400 g/lin.m

Abrasion resistance 80.000 Martindale rubs, EN ISO 12947

Flammability EN 1021-1/2 | BS 5852, ignition source 2-3 | DIN 4102 B2
NF D 60 013 | UNI 9175 1IM | US Cal. Tech. Bull. 117, Sec. E
NFPA 260 | IMO A.652(16)

Fastness to light Note 5-7, ISO 105-B02

Fastness to rubbing (ISO) dry 4-5, wet 4

Pilling Note 4, EN ISO 12945



Remix 2

kvadrat



Category B

Composition 90% new wool, 10% nylon

Weight 415 g/lin.m

Abrasion resistance 100.000 Martindale rubs, EN ISO 12947

Flammability EN 1021-1/2 | BS 5852 part 1

Önorm B1/Q1 | NF D 60 013 | UNI 9175, 1IM

AS/NZS 1530.3 | Cal. Tech. Bull. 117-2013

NFPA 260 | IMO FTP Code 2010:Part 8

Fastness to light Note 5-7, ISO 105-B02

Fastness to rubbing (ISO) dry 4-5, wet 4

Pilling Note 4, EN ISO 12945



Tartan (Not for 3D rib)



Category C

Composition 100% Pure New Wool

Weight 475 g/m²

Abrasion resistance 30.000 Martindale

Flammability EU: BS5852 CRIB 5 | BS5867 PART 2 : 2008 : TYPE B

EN 1021.2/2006 | USA: CAL TB 117

Fastness to light EU: 5 | USA: 5

Fastness to rubbing EU: Wet: 4 | Dry: 4



Hero

kvadrat

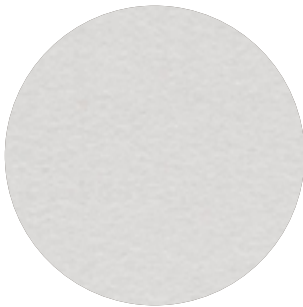

Category C

Composition 96% new wool, 4% nylon

Weight 580 g/lin.m

Abrasion resistance 45.000 Martindale rubs, EN ISO 12947

Flammability EN 1021-1/2 | DIN 4102 B2 | NF D 60 013

UNI 9175 1IM | US Cal. Bull. 117-2013 | NFPA 260

IMO A.652 (16)

Fastness to light Note 5-6, ISO 105-B02

Fastness to rubbing (ISO) dry 4-5, wet 4-5

Pilling Note 3-4, EN ISO 12945



Tonus 4

kvadrat



Category D

Composition 90% new wool, 10% Helanca

Weight 665 g/lin.m

Abrasion resistance 100.000 Martindale rubs, EN ISO 12947

Flammability EN 1021-1/2 | BS 5852 part 1 | DIN 4102 B2

Önorm B1/Q1 | NF D 60 013 | UNI 9175 1IM

US Cal. Bull. 117-2013 | NFPA 260 | IMO A.652 (16)

Fastness to light Note 5-7, ISO 105-B02

Fastness to rubbing (ISO) dry 3-5, wet 3-5

Pilling Note 3, EN ISO 12945



Tonus Meadow

kvadrat

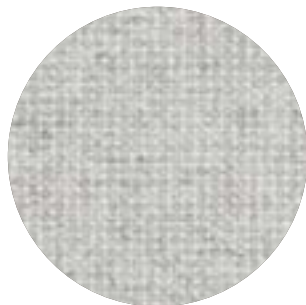

Category D

Composition 90% new wool, 10% Helanca

Weight 665 g/lin.m

Abrasion resistance 100.000 Martindale rubs, EN ISO 12947

Flammability EN 1021-1/2 | BS 5852 part 1 | DIN 4102 B2

Önorm B1/Q1 | NF D 60 013 | UNI 9175 11M

US Cal. Bull. 117-2013 | NFPA 260 | IMO A.652 (16)

Fastness to light Note 5-7, ISO 105-B02

Fastness to rubbing (ISO) dry 4-5, wet 4

Pilling Note 3, EN ISO 12945



Memory 2

kvadrat



Category E

Composition 100% Trevira CS

Weight 700 g/lin.m

Abrasion resistance

35.000 rubs acc. to the Martindale method, EN ISO 12947

Flammability EN 1021-1/2 | DIN 4102 B1 | Önorm B1/Q1

NF D 60 013 | NF P 92 507 M1 | UNI 9175 11M

UNI 9177 classe 1 | US Cal. Tech. Bull. 117

IMO A.652 (16)

Fastness to light Note 5-8, ISO 105-B02

Fastness to rubbing (ISO) dry 4-5, wet 4-5

Pilling Note 4, EN ISO 12945



Matrix

kvadrat

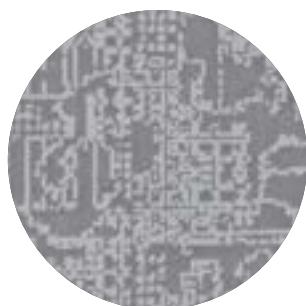

Category F

Composition 100% Trevira CS

Weight 760 g/lin.m

Abrasion resistance

App. 60.000 rubs acc. to the Martindale method, EN ISO 12947

Flammability EN 1021-1/2 | BS 5852 crib 5 | BS 5867 part 2 type B

DIN 4102 B1 | Önorm B1/Q1 | NF D 60 013

UNI 9175 11M | US Cal. Tech. Bull. 117 | NFPA 701

IMO A.652 (16)

Fastness to light Note 5-7, ISO 105-B02

Fastness to rubbing (ISO) dry 4-5, wet 4-5

Pilling Note 4, EN ISO 12945



Fixing System (included)

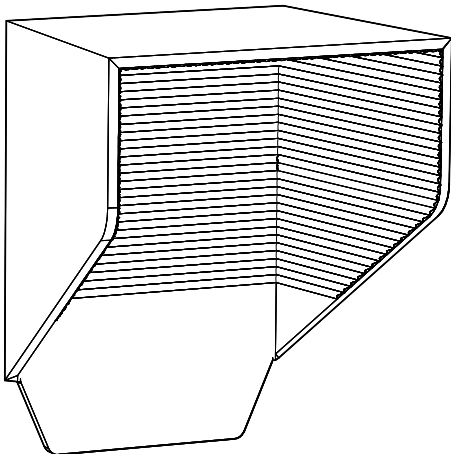

2pcs

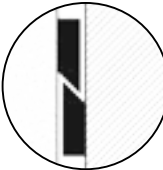
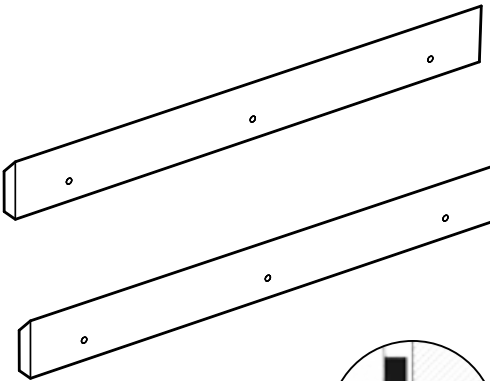

Dimensions

BuzziHood

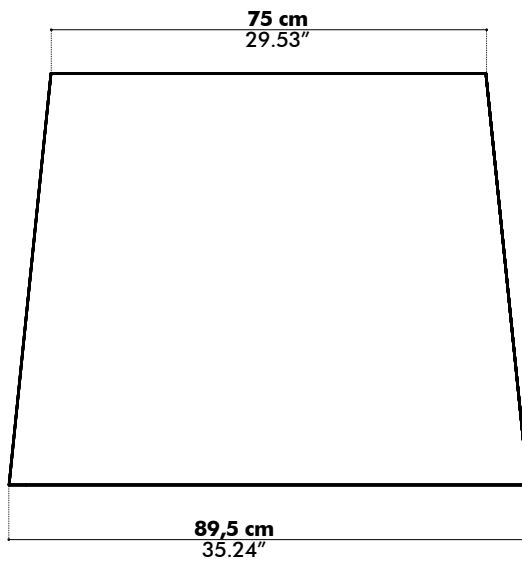
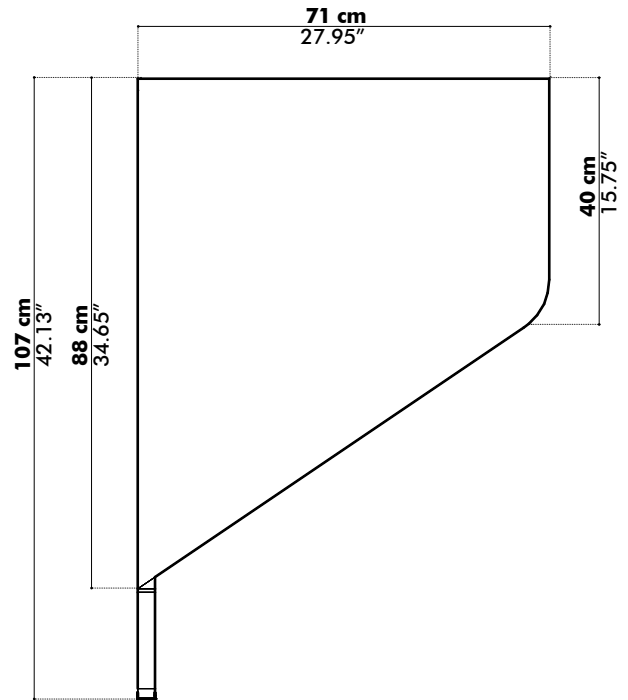
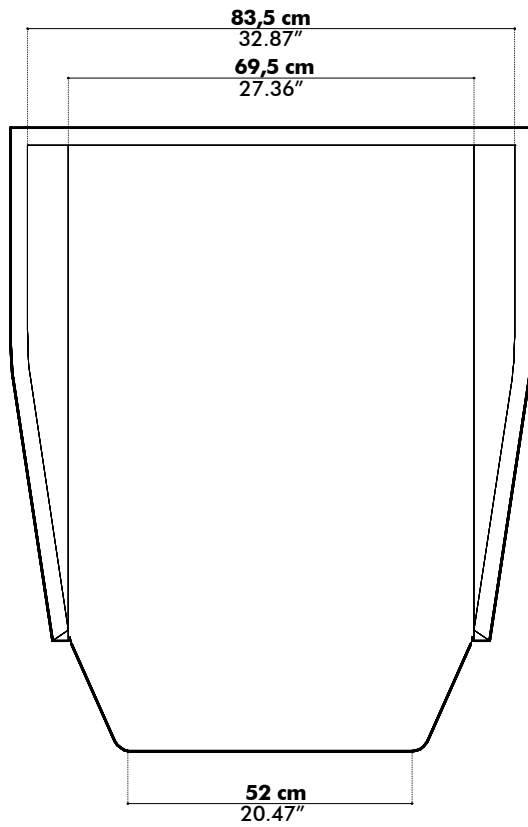

Tablet

Wood

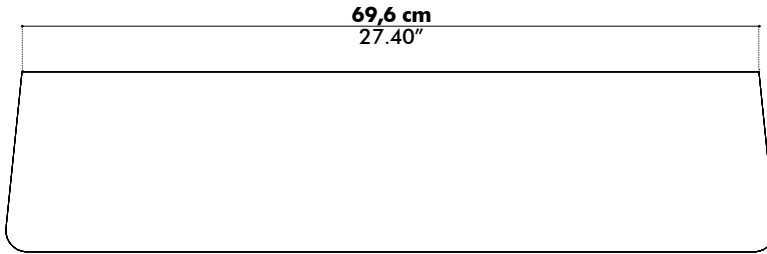
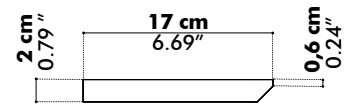
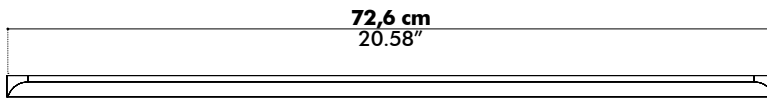

Metal

