

President



President

A directional system that is combined with a perfect aesthetics balance and functionality. A bridge between managerial furniture and refined meeting spaces, where to meet up and communicate.

Um sistema direccional que é combinado com um equilíbrio perfeito, estética e funcionalidade.

Uma ponte entre móveis presidenciais e espaços de reunião refinados.





.4

.5



.6

.7

President

Elegant combination of shape, function and materials. A smart choice of volumes, and chrome surfaces that create a perfect balance between functional and operational service elements. An eclectic solution, not just an image, for every need of furniture.

.8

Elegante combinação de formas, função e materiais. A escolha inteligente de volumes e superfícies cromadas que criam um equilíbrio perfeito entre elementos de serviço funcionais e operacionais. Uma solução eclética, e não apenas uma imagem, para todas as necessidades de mobiliário.



Integrated electrification on the desktop and on the underlying structure. The technical elements, materials and details combine a design that enhances quality, comfort and representativeness.

.10

Eletrificação integrado no ambiente de trabalho e na estrutura subjacente. Os elementos técnicos, materiais e detalhes combinam um design que melhora a qualidade, conforto e representatividade.



.11















Combining materials of prestige and absolute minimalism, this is the feature of the meeting tables, a system in which the simplicity of the structures that supports the surfaces connects with the world.

Combinação absoluta de materiais de prestígio e minimalista ,com uma funcionalidade das mesas de reunião, um sistema em que a simplicidade das estruturas que suportam as superfícies se conecta com o mundo.







President

Not only a system of storing containers, but a tool for organizing and completing the space and work. Straight and essential lines integrates with the large desks.

não é apenas um sistema de armazenamento, mas uma ferramenta para organizar e completar o espaço e trabalho. As linhas retas e essenciais integram-se com as grandes mesas.

.28



.29



01



02

An evolution for the container, the architecture of the elements, materials and proportions is suitable for any space and situation, configuring endless compositions.

Uma evolução para o recipiente, a arquitetura dos elementos, materiais e proporções é adequado para qualquer espaço e situação, configurando composições infinitas..



03



04



05



06

DESKS AND CONTAINERS - MESAS E APARADORES



RT

Tobacco oak wood



RR

Natural oak wood -



RM

Honey Oak wood



RG

Grey Oak wood



RK

Black laquered Oak wood

**PARTES METALICAS
METAL PARTS**

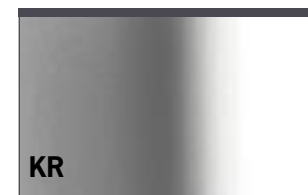

KR

Glossy chrome-painted

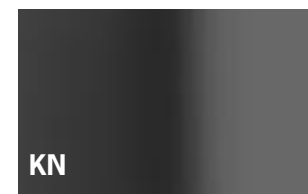

KN

Glossy Nickel-painted

**LACADO PULIDO
GLOSSY
LACQUERED**

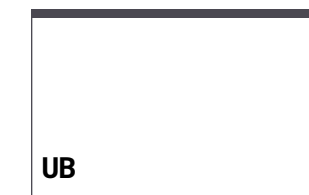

UB

Glossy White Lacquered

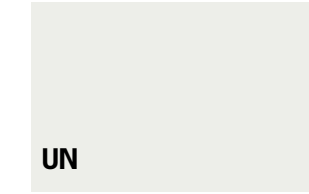

UN

Glossy Fog Lacquered



UT

Glossy Tortora Lacquered



UA

Glossy Titanio Lacquered

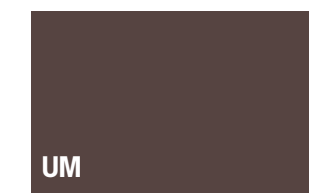

UM

Glossy Moka Lacquered

**PORTAS LACADAS
COLORED GLASS DOORS**



SB

Mat white tempered glass

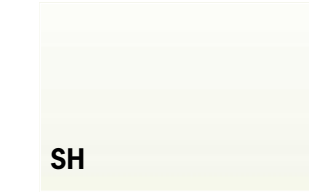

SH

Mat Nebbia tempered glass

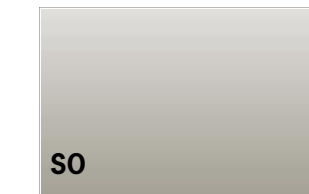

SO

Mat Tortora tempered glass

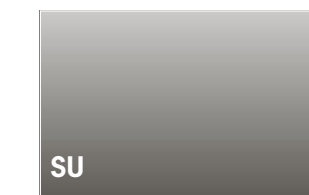

SU

Mat Titanio tempered glass

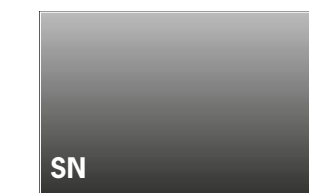

SN

Mat black tempered glass

**PORTAS DE VIDRIO
GLASS DOORS**



CS

glass frosted on both sides

**CABINET FRAMES
ESTRUCTURA ARMARIOS**



NE

Gloss black

President

WOODEN DESKS - MESAS DE MADEIRA

- MÓDULOS PARA MESAS

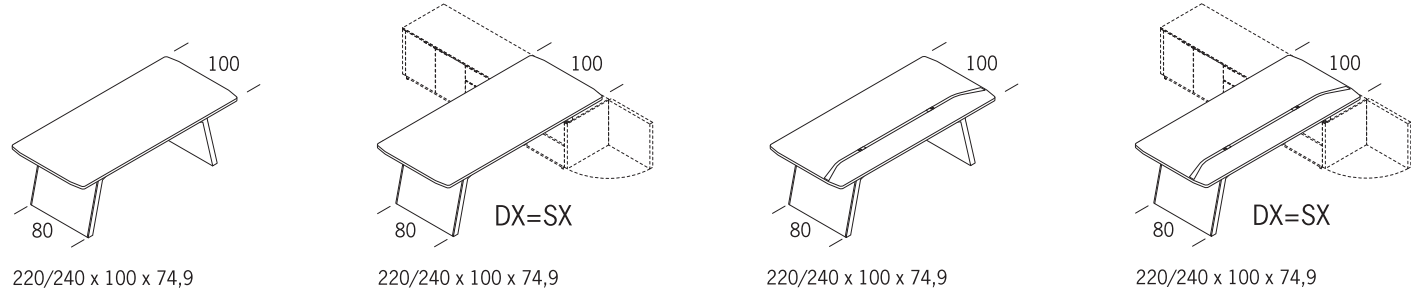

SERVICE MODULES - MÓDULOS PARA MESAS

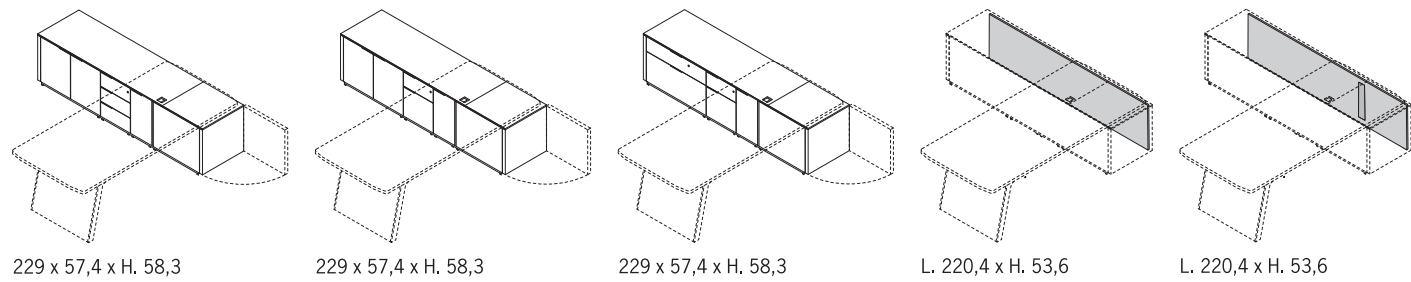

SERVICE MODULES ARMARIOS



CABINETS - ARMARIOS

L. 50 L. 100

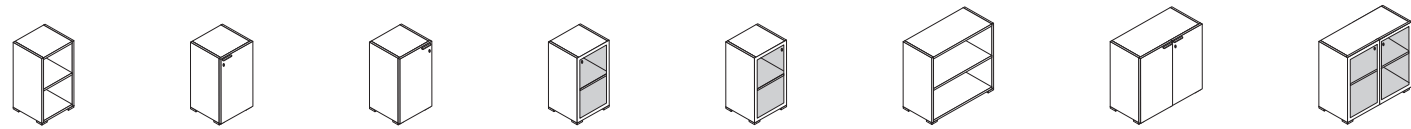

CABINETS - ARMARIOS

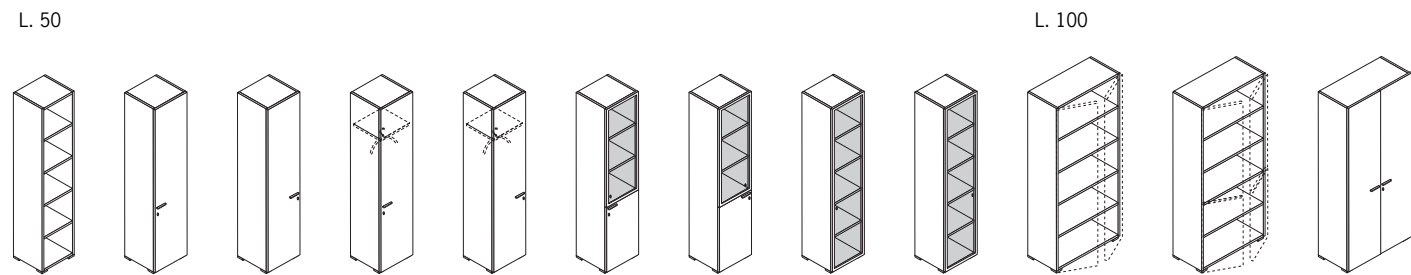

MODESTY PANEL - PAINEL

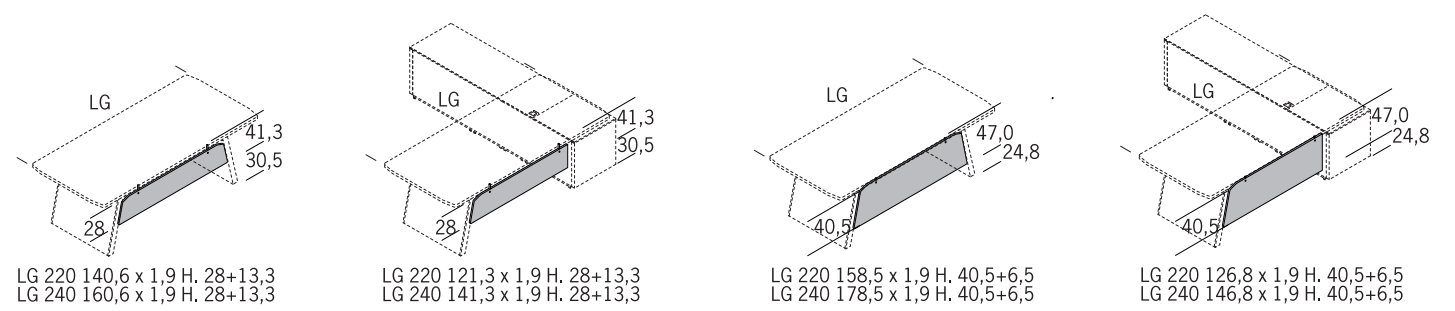

CONVERSATION TOP PLANO REUNIAO

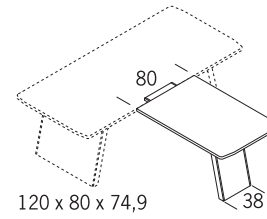

CABLES HOLDER BASKETS CESTO PORTA CABOS

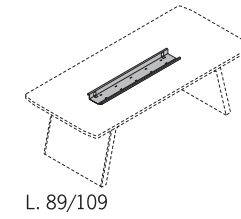

COFFEE TABLE MESA DE CENTRO

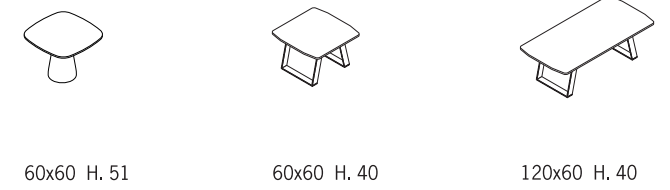

MEETING TABLES - MESAS REUNIOES

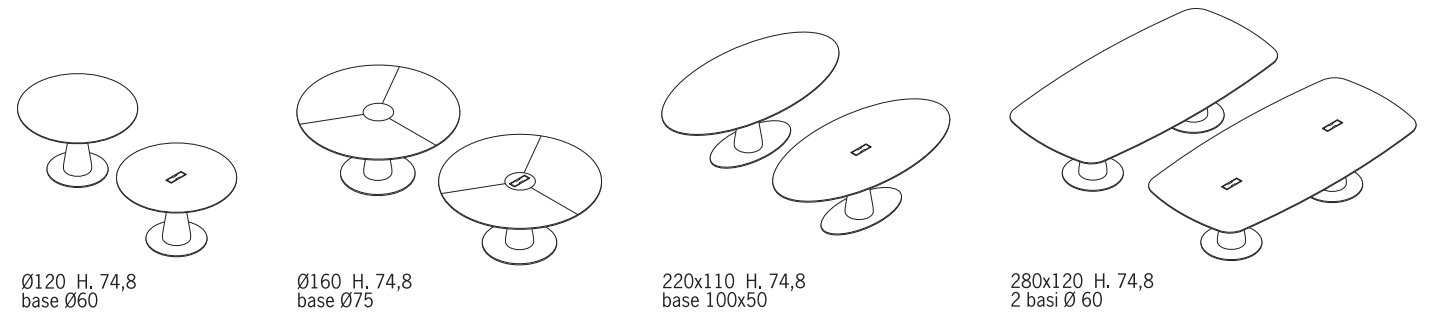

CABINETS - ARMARIOS

L. 50 L. 100

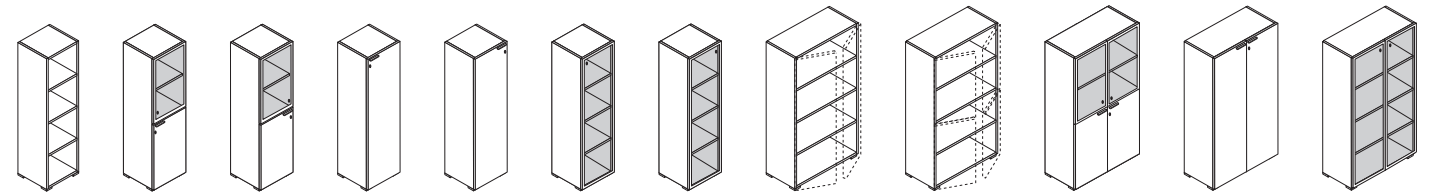

TOP PARTE SUPERIOR

CLOSING SIDES - FLANCS DE FINITION ENCERRAMENTO DOS LADOS -

