

## Auditoriumchair – A1 series

Opus :



Material of wood: birch plywood, varnished

Textile: Manufacturer Camira Fabrics Ltd  
• Main Line Plus 75000 Martindale  
• Xtreme Plus 100000 Martindale

Frame: 25 x 40 mm steel frame, powder painted, choice of a various grey tones according to RAL palette



### Variety

Material of wood: surface layers beech or oak veneer

Finishing: stained and varnished covered with high pressured laminate only seat upholstered with textile seat and back upholstered with textile

Frame: choice of a various grey tones according to RAL

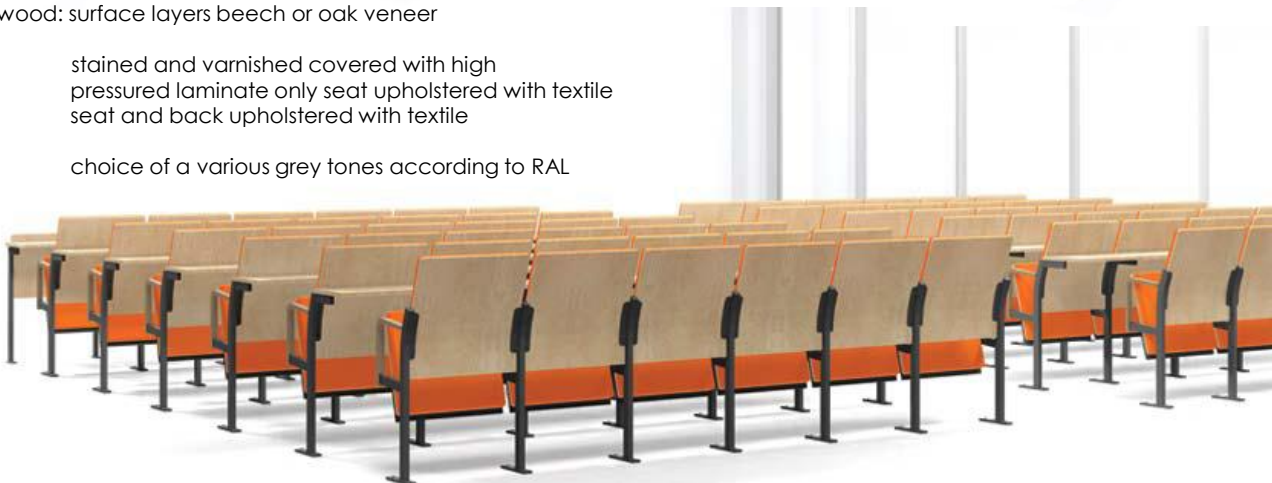

Auditoriumchair – A1 series

Opus :



on 100 mm step

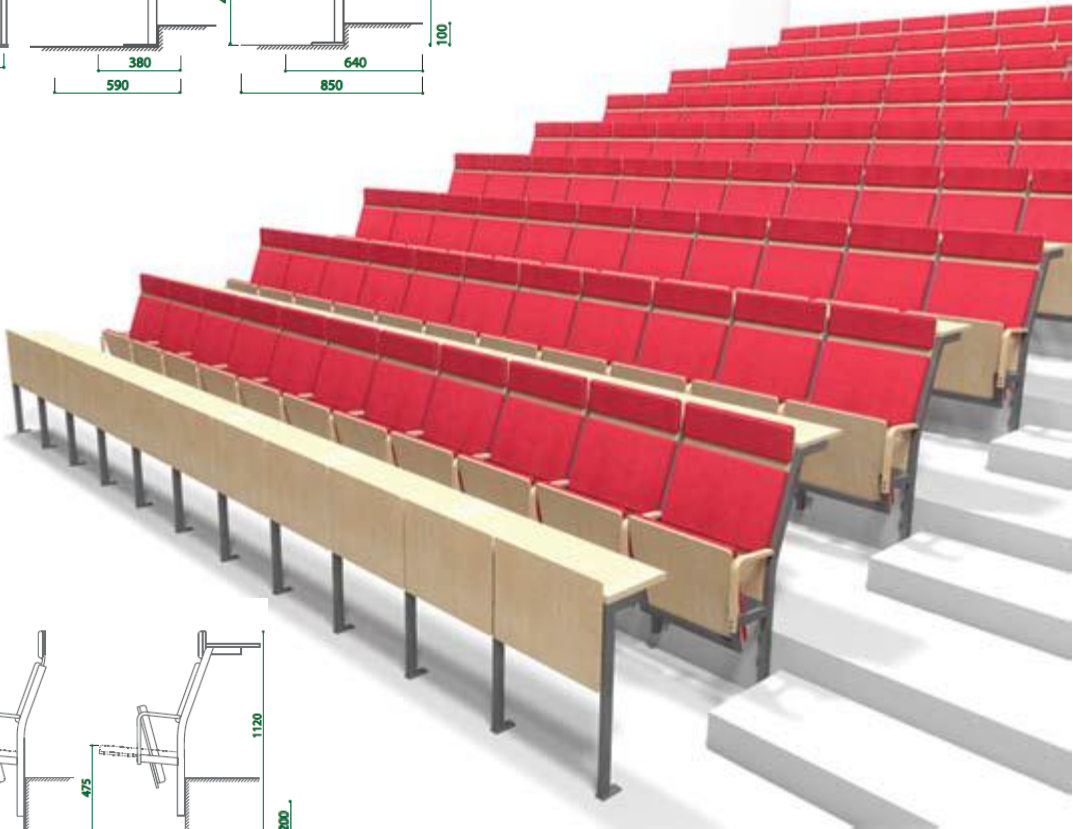
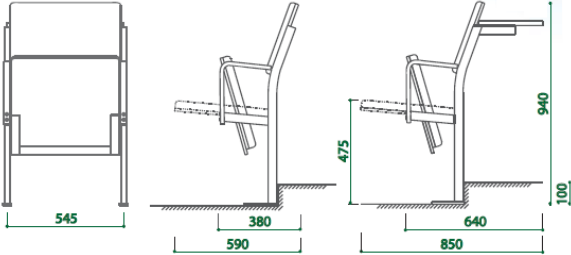

on 200 mm step

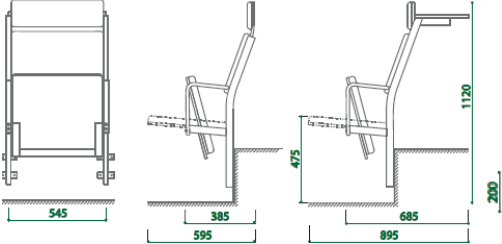

Auditoriumchair – A1 series

Opus :

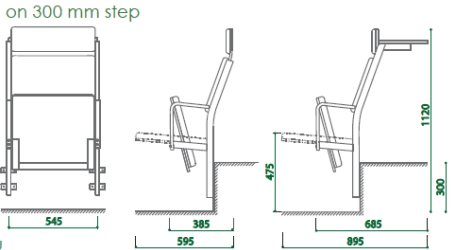

University Barcelona



Auditoriumchair – A1 series

Opus :

on 400 mm step

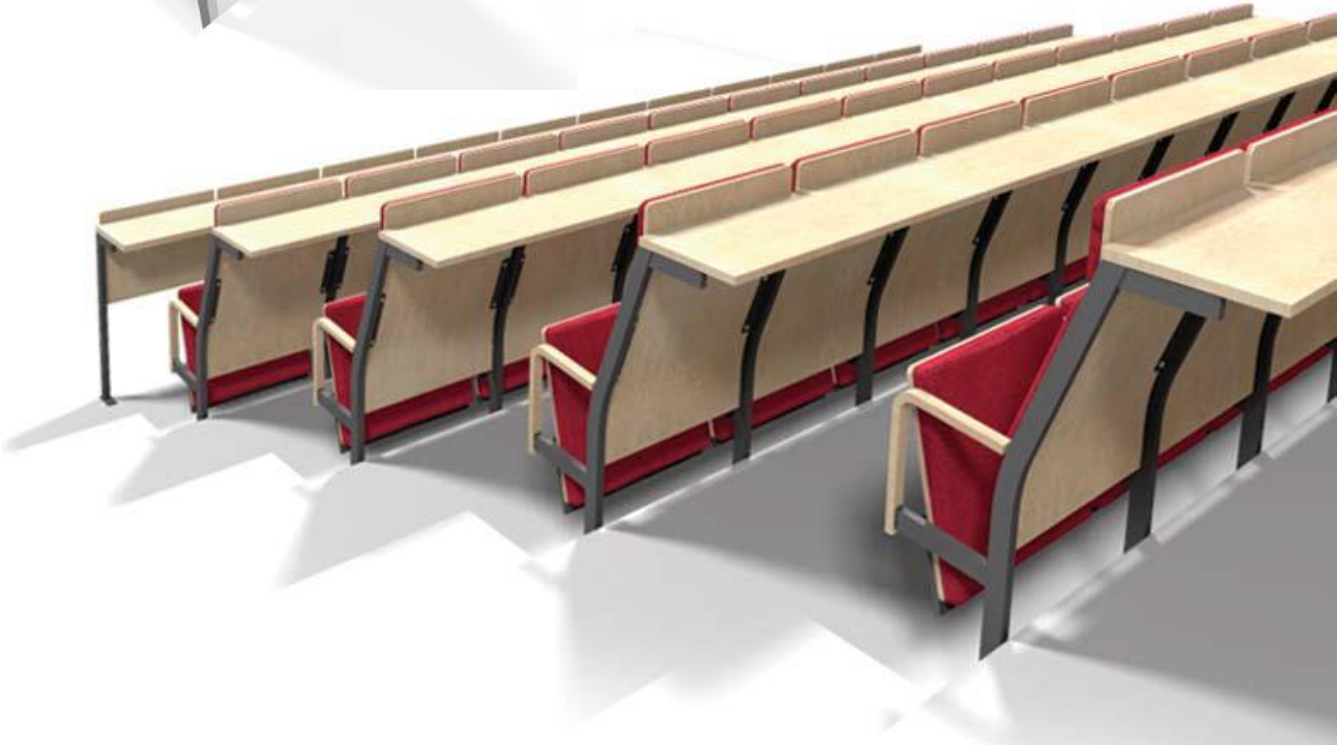
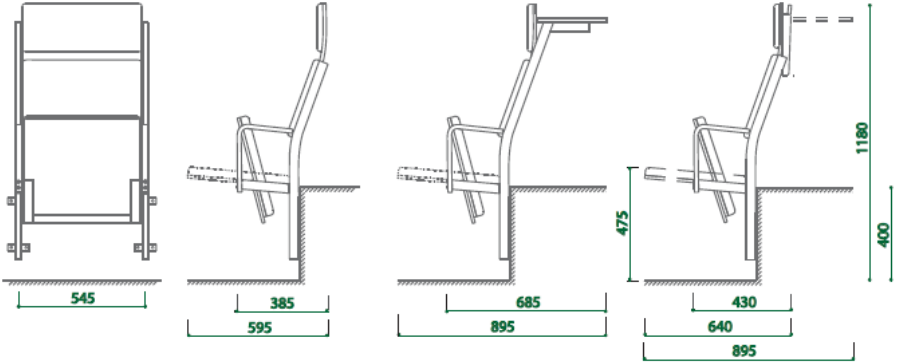

# Auditoriumchair – A1 series

Opus :

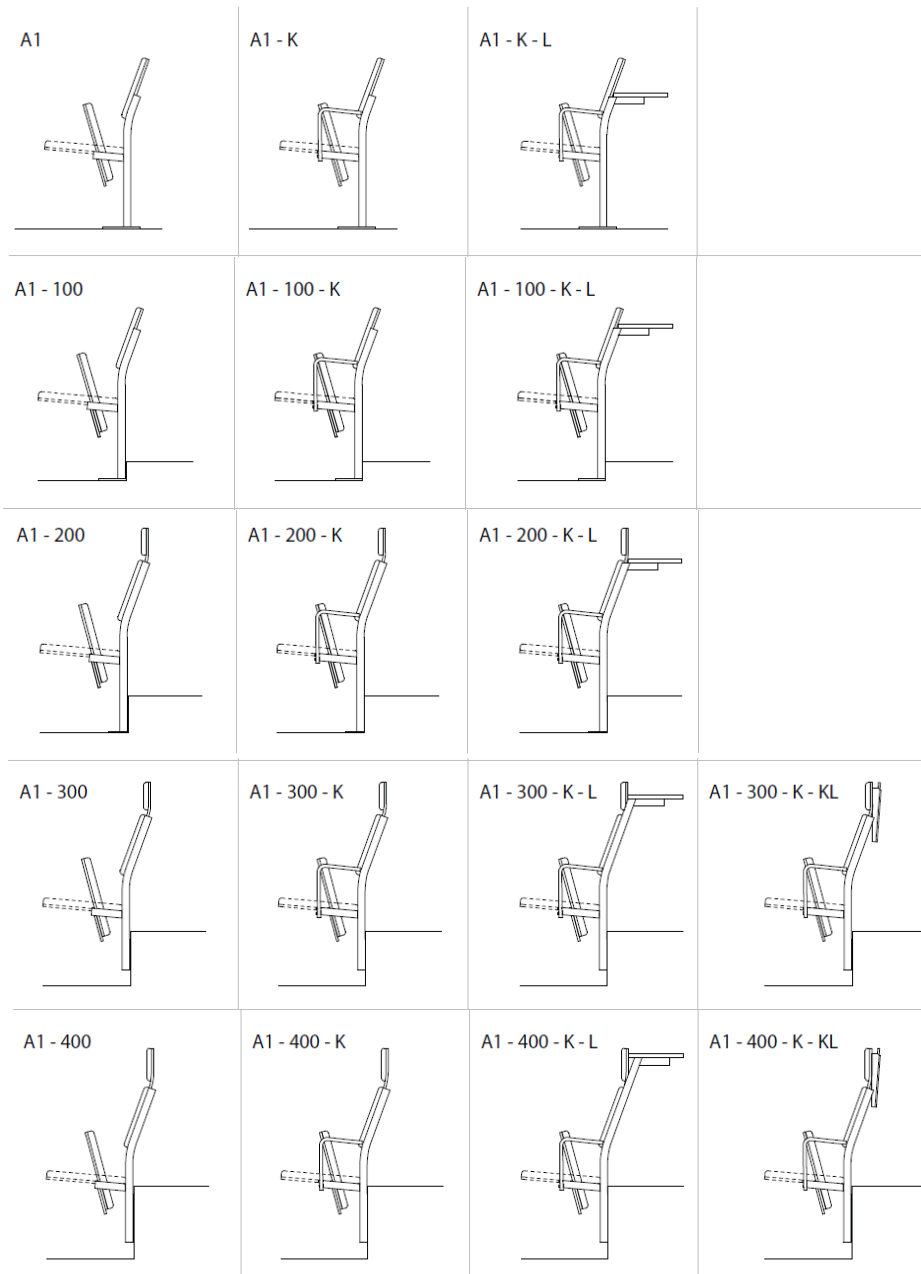

Material of wood:

Textile:

Frame:

## Variety

Material of wood:

Finishing:

birch plywood, varnished

Manufacturer Camira Fabrics Ltd

- Main Line Plus 75000 Martindale
- Xtreme Plus 100000 Martindale

25 x 40 mm steel frame, powder painted, choice of a various grey tones according to RAL

surface layers beech veneer  
surface layers oak veneer

stained and varnished  
covered with high pressured laminate  
only seat upholstered with textile  
seat and back upholstered with textile

## Plane

- level
- 100 mm step
- 200 mm step
- 300 mm step
- 400 mm step

## Additions

K - armrest  
L - table  
KL - folding table  
N - hook for bag