



CONTRACT
COLLECTION
2013

LUCENTE®

INDICE - INDEX

AIDA	183	GALASSIA	211	OLLY	88
AIN	130	GEA	162	OLYMPIA	62
AI-PI	194	GINGER	36	OMNI	210
AI-PI INOX	192	GLEN	150	ONSEN	205
ALTEA	102	GRIFO	190	OSTER	206
ANKE	32	HOOK	214	POCKET	215
ARGO	146	HOT	164	POOL	2
ASTRATTA	140	HUT / BIG HUT	208	POSI / POSI WAVE	84
BAAN	160	IDROO	198	RANDA	60
BELL	122	INTERNOS	114	RHA	92
BOREALE	144	ISOTTA	188	RING	212
BRACKET	216	JAKI	46	SAIL	180
BRICK	132	JAZZ	76	SAMURAI	180
BRIGHT	170	JEF	154	SQ_EASY	202
DIECIDIECI	209	JOLE	185	SQUARE	176
DOMINO	168	KLYPTA	184	STADIUM	187
ECO	128	KOMET	213	TAIA	56
ELLA	118	LAYLA	16	TASCA	124
EMY	110	LEA	52	TESSA	24
EOS	189	LINA	106	TRATTO	126
EQUAL	70	LUNA	186	TRIM	142
FLY	80	METI	98	TWIST	138
FLOAT	204	MINI	10	VISION	74
FLORA	28	MIRYA	6	WALL	134
FLUONIGHT	166	MOON	217	ZAC	66
FUNNY	18	NUVOLA	182	ZEN	72
GAIA	172	O-LAMP	148	ZERO	70

POOL

design Lucente Lab

Lampada a sospensione in metallo disponibile nelle finiture verniciato lucido bianco e nelle versioni bicolore verniciato lucido nero-bianco e verniciato lucido rosso-bianco.

Metal pendant lamps available in lacquered white and on the two-colour versions lacquered black/white or lacquered red/white

Suspension en métal, disponible uni verni blanc brillant ou bicolore vernis brillant Blanc/Noir ou Rouge/Blanc.

Pendelleuchte aus lackiertem Metall. Erhältlich in Weiß poliert und in den zweifarbigen Versionen: Schwarz/ Weiß poliert und Rot/Weiß poliert.

Lámpara colgante de metal disponible en blanco pintado brillante y en las versiones con dos colores negro-blanco pintado brillante y rojo-blanco pintado brillante.

Подвесной светильник из металла. Может быть окрашен полностью в блестящий белый цвет или быть двуцветным: блестящим бело-черным или блестящим красно-белым.



Finiture Finishings



16
Bianco lucido
Glossy white



74
Rosso/bianco lucido
Glossy red/white



46
Nero/bianco lucido
Glossy black/white

	ELECTR.	SOCKET	LAMP	CODE	FINISHING
SOSPENSIONE PENDANT	1x77W	E27	ECO	T355	16 - 74 - 46

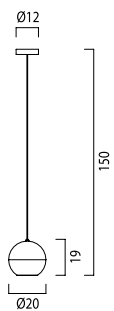

Sospensione - Pendant
 CE V \oplus IP20 P



POOL





Lampada a sospensione e soffitto in tessuto avorio. Struttura metallica verniciata. Diffusore inferiore diffondente in Pmma satinato bianco.

Ivory fabric pendant and ceiling lamps. Painted metal structure. Opal satined Pmma diffuser.

Luminaire en tissu de couleur Ivoire avec structure métallique vernis. Diffuseur inférieur en PMMA opale. Existe en suspension et plafonnrière.

Pendel und Deckenleuchte aus Stoff in Elfenbeinfarbe. Struktur in lackiertem Metall. Diffuser scheinbe in PMMA Opal.

Lámpara colgante y de techo. Estructura metálica barnizada. Difusor en tejido marfil. Difusor de PMMA mate.

Подвесной и потолочный светильник. Имеет окрашенную металлическую структуру, на которую натянута светлорбежевая ткань. Матовый акриловый рассеиватель.

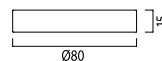

Soffitto - Ceiling Ø80
CE V IP 20 P

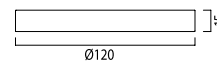

Soffitto - Ceiling Ø120
CE V IP 20 P

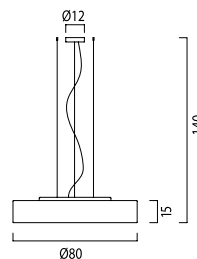

Sospensione - Pendant Ø80
CE V IP 20 P

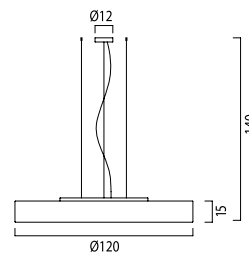

Sospensione - Pendant Ø120
CE V IP 20 P

	ELECTR.	SOCKET	LAMP	CODE	FINISHING
SOFFITTO CEILING Ø80	4x30W	E27	TC-TSE	T354	02
SOFFITTO CEILING Ø120	5x30W	E27	TC-TSE	T353	02
SOSPENSIONE PENDANT Ø80	4x30W	E27	TC-TSE	T352	02
SOSPENSIONE PENDANT Ø120	5x30W	E27	TC-TSE	T351	02





MIRYA



MINI

design Lucente Lab

**Struttura in metallo e base in alluminio
pressofuso verniciato bianco opaco.
IP44 per la versione da parete e soffitto.**

Matt white painted metal structure
and die-cast aluminium base.
IP44 rated on wall and ceiling light.





Structure en métal et base en aluminium
verniss en blanc mat. IP44 pour la
lampe murale et plafonnier.

Matt weiß lackierte Metallstruktur in Würfelform.
Fuß aus druckgegossenem Aluminium matt weiß
lackierte. Wand und Deckenleuchte IP44.

Lámparas en metal barnizado en blanco mate.
Base de aluminio vaciado a presión barnizado en
blanco mate. IP 44 en los modelos
de pared y de techo.

Корпус из металла, база из алюминия.
Окрашенный в белый цвет. Возможные
варианты: подвесной, потолочный, настенный
и настольный. Настенная и потолочная модели
имеют степень защиты IP44.



	ELECTR.	SOCKET	LAMP	CODE	FINISHING
SOSPENSIONE PENDANT	1x48W	G9	QT-13 	T344	16
SOFFITTO CEILING	1x48W	G9	QT-13 	T345	16
PARETE WALL	1x48W	G9	QT-13 	T346	16
TAVOLO TABLE	1x48W	G9	QT-13 	T347	16

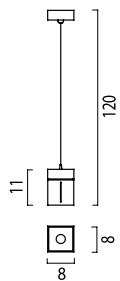

Sospensione - Pendant
CE **V** **IP 20** **P**

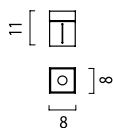

Soffitto - Ceiling
CE **V** **IP 44** **P**

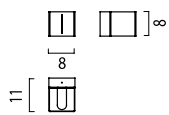

Parete IP44 - Wall IP44
CE **V** **IP 44** **P**

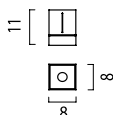

Tavolo - Table
CE **V** **IP 20** **P**



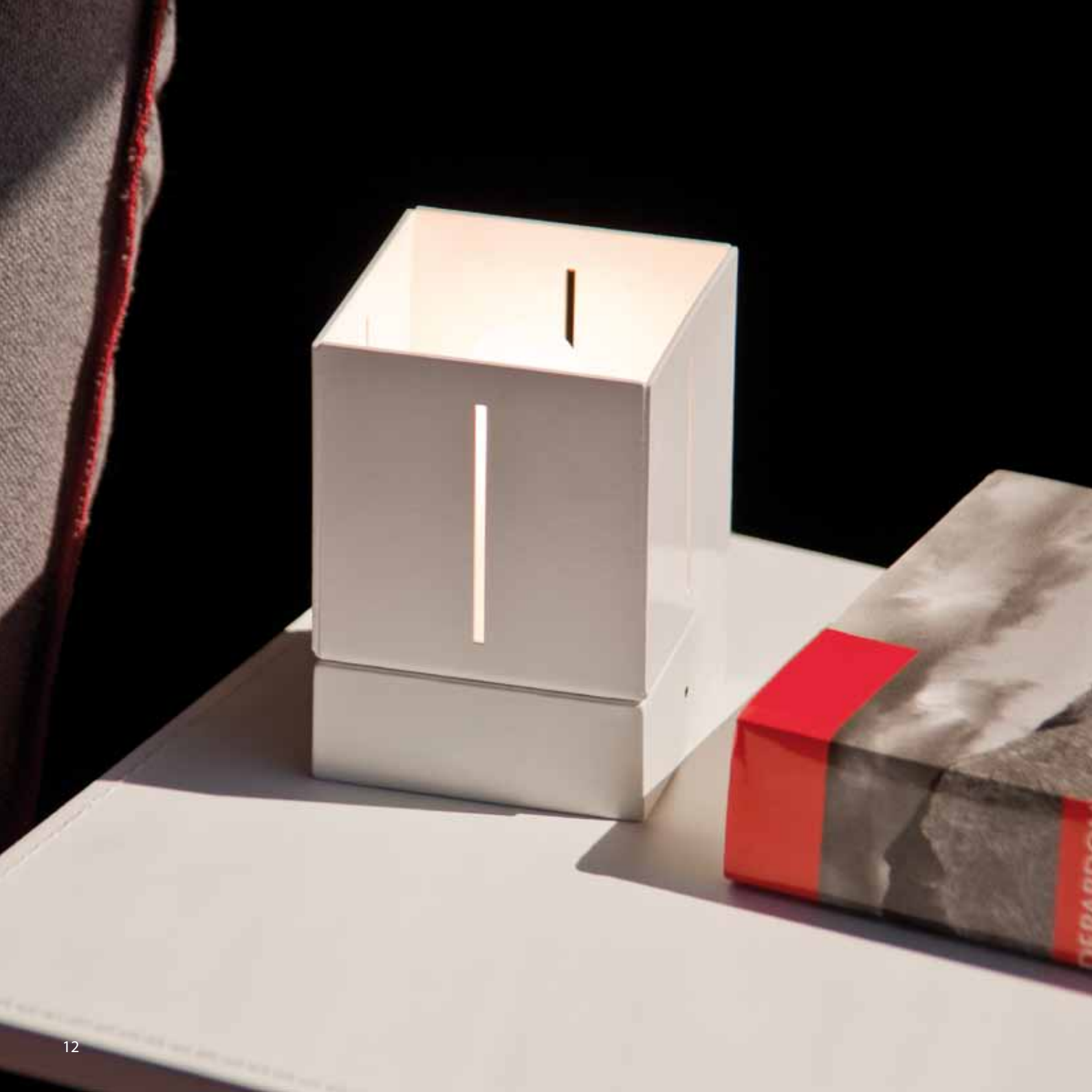



MINI





LAYLA

design Lucente Lab

Lampada da parete di alluminio verniciato bianco. Riflettore orientabile in alluminio.

Wall light in white painted aluminium. Adjustable aluminium reflector.

Wandleuchte in weiß gestrichenem Aluminium. Reflektor schwenkbar.

Structure en aluminium verni blanc. Réflecteur orientable.

Lámpara de pared de aluminio barnizado blanco. Reflector de aluminio ajustable.

Настенный светильник с корпусом из алюминия, окрашенного в белый цвет. Ориентируемый отражатель из чистейшего алюминия.

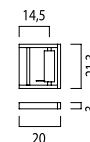

	ELECTR.	SOCKET	LAMP	CODE	FINISHING
PARETE WALL	1x120W	R7s 118mm	QT-DE 	T350	16

Parete - Wall
   



FUNNY

design Lucente Lab

Struttura in metallo verniciato nei colori bianco lucido e rosso metallizzato. Diffusore inferiore e superiore in vetro satinato. Struttura cromata nella versione da tavolo e terra

Painted metal structure available in glossy white and metallic red. Top and bottom satin glass diffusers. Chromed metal structure for table and floor lamps.





Structure en métal verni disponibles en rouge métallisé ou blanc brillant. Diffuseurs inférieur ou supérieur en verre satiné. Lampe de table et lecture avec structure chromé.

Struktur aus lackiertem Metall in den Farben glänzend Weiß und Rot metallisiert. Verfügbar als Hänge-, Steh- und Tischlampe. Unterer und oberer Lichtverteiler aus satiniertem Glas.

Lámparas en metal barnizado en los colores blanco brillo y rojo metalizado. Difusores en vidrio satinado. Estructura de metal cromado para lámpara de mesa y de pié.

Корпус из металла окрашенный в блестящий белый или металлический красный цвета. Два рассеивателя из матового белого стекла.



	ELECTR.	SOCKET	LAMP	CODE	FINISHING
SOSPENSIONE PENDANT Ø24	3x48W	G9	QT-13 	T332	09 - 16
SOSPENSIONE PENDANT Ø40	3x53W	E27	A55 	T333	09 - 16
SOSPENSIONE PENDANT Ø40	1x55W	2GX13 electr.	T5c 	T334	09 - 16
TAVOLO TABLE	3x48W	G9	QT-13 	T336	09 - 16
TERRA FLOOR	3x53W	E27	A55 	T335	09 - 16

Finiture Finishings



16
Bianco lucido
Glossy white



09
Rosso
metallizzato
Metallic red

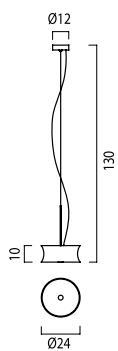

Sospensione - Pendant
 CE V A IP 20 P

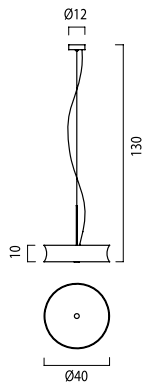

Sospensione - Pendant
 CE V A IP 20 P

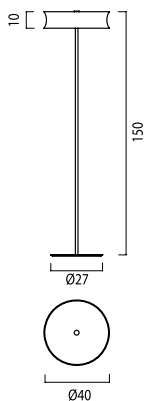

Terra - Floor
 CE IP 20 P

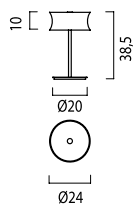

Tavolo - Table
 CE IP 20 P



FUNNY







FUNNY



TESSA

design Lucente Lab

Lampade in tessuto disponibili nei colori avorio e rosso.

Range of fabric lamps available in ivory and red.





Lampe en tissu disponible en couleur: ivoire ou rouge. Structure vernis métallique.

Lampenmodellpalette aus Stoff, erhältlich als Hänge- (in zwei Größen) oder Tischlampe in den Farben Elfenbein und Rot.

Lámparas con difusor en tejido rojo y marfil.

Серия светильников из ткани.
Цвета: красный, слоновая кость.



	ELECTR.	SOCKET	LAMP	CODE	FINISHING
SOSPENSIONE PENDANT H30	1x21W	E27	TC-TSE 	T337	02 - 14
SOSPENSIONE PENDANT H50	1x21W	E27	TC-TSE 	T338	02 - 14
SOSPENSIONE PENDANT H30	2x21W	E27	TC-TSE 	T339	02 - 14
SOSPENSIONE PENDANT H50	2x21W	E27	TC-TSE 	T340	02 - 14
TAVOLO TABLE	1x21W	E27	TC-TSE 	T341	02 - 14

Varianti tessuto Fabric colour options



02
Avorio
Ivory



14
Rosso
Red

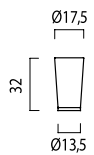

Tavolo - Table

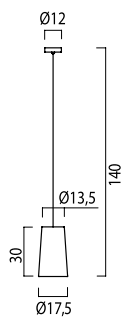
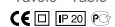

Sospensione - Pendant H30

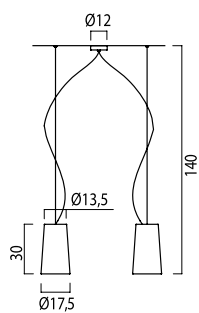

Sospensione - Pendant H30

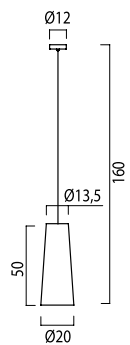

Sospensione - Pendant H50

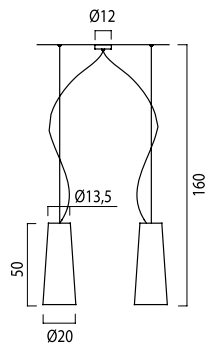

Sospensione - Pendant H50

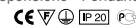



TESSA



FLORA

design Roberto Favaretto

**Diffusore in vetro soffiato
satinato: opale e ambra.
Struttura in metallo cromato.**

Satin blown glass: opal and amber.
Chrome metal structure.

Diffuseur en verre soufflé: opale et
ambre. Structure en métal chromé.

Gebblasenem Glas: Opal und Bernstein.
Struktur aus verchromtem Metall.

Difusor en vidrio soplado
satinado: opal y àmbar.
Estructura en metal cromado.

Рассеиватель из дутого
матового стекла, янтарного
и белого цвета. Структура из
хромированного металла.

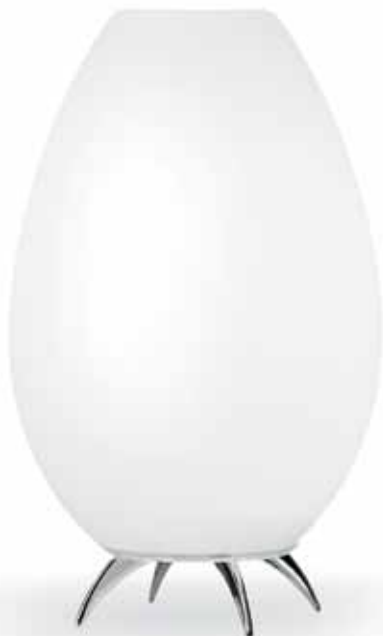

	ELECTR.	SOCKET	LAMP	CODE	FINISHING
PARETE WALL	1x42W	E14	P45	010237	Opale satinato - Satin opal
PARETE WALL	1x42W	E14	P45	010241	Ambra satinato -Satin amber
SOFFITTO CEILING	1x42W	E14	P45	009204	Opale satinato - Satin opal
SOFFITTO CEILING	1x42W	E14	P45	009209	Ambra satinato -Satin amber
SOSPENSIONE PENDANT Ø14	1x42W	E14	P45	009077	Opale satinato - Satin opal
SOSPENSIONE PENDANT Ø14	1x42W	E14	P45	009083	Ambra satinato -Satin amber
SOSPENSIONE PENDANT Ø18	1x52W	E27	A55	009015	Opale satinato - Satin opal
SOSPENSIONE PENDANT Ø18	1x52W	E27	A55	009021	Ambra satinato -Satin amber
TAVOLO TABLE Ø14	1x42W	E14	P45	009057	Opale satinato - Satin opal
TAVOLO TABLE Ø14	1x42W	E14	P45	009062	Ambra satinato -Satin amber
TAVOLO TABLE Ø18	1x70W	E27	A55	009080	Opale satinato - Satin opal
TAVOLO TABLE Ø18	1x70W	E27	A55	009084	Ambra satinato -Satin amber
TERRA FLOOR	1x205W	E27	QT-32	009128	Opale satinato - Satin opal
TERRA FLOOR	1x205W	E27	QT-32	009131	Ambra satinato -Satin amber

Varianti vetro
Glass colour options

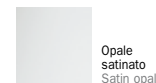

Opale
satinato
Satin opal

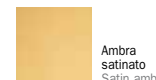

Ambra
satinato
Satin amber

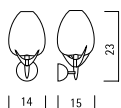

Parete - Wall
 CE V IP20 P

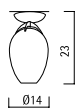

Soffitto - Ceiling
 CE V IP20 P

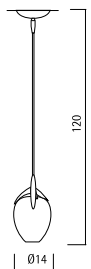

Sospensione
 Pendant Ø14
 CE V IP20 P



Tavolo - Table Ø14
 CE IP20 P

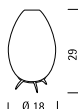

Tavolo - Table Ø18
 1x24W E27 TC-TSE
 CE IP20 P

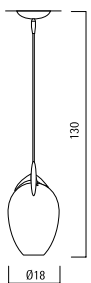

Sospensione
 Pendant Ø18
 1x24W E27 TC-TSE
 CE V IP20 P

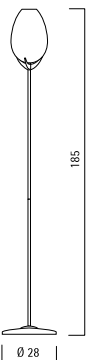

Terra - Floor
 1x24W E27 TC-TSE
 CE IP20 P



FLORA





ANKE design Lucente Lab

Sospensioni in metallo verniciato nelle finiture: nero lucido esterno e interno bianco o arancio lucido; bianco lucido esterno e interno bianco o arancio lucido. Montatura con finiture in cromo.

Metal pendant lamps available in the following colours: Glossy black (on the) outside and glossy white or orange inside; Glossy white (on the) outside and glossy white or orange inside. Chrome details on the metal structure.

Suspensions en métal disponibles dans les versions suivantes: Extérieur verni noir brillant et intérieur verni blanc ou orange brillant; Extérieur verni blanc brillant et intérieur verni blanc ou orange brillant. Corps avec finitions chrome.

Pendelleuchte in Metall, erhältlich in folgenden Farben: aussen schwarz glänzend und innen weiß oder orange; aussen weiß glänzend und innen weiß oder orange. Metallteile in chrom.

Lampara suspendida realizada en metal disponible en los siguientes acabados: lacado negro brillo externamente e internamente blanco brillo o naranja brillo; lacado blanco brillo externamente e internamente blanco brillo o naranja brillo. Soporte superior en acabado cromo.

Металлические, хромированные подвесные светильники могут быть следующих цветов; чёрный снаружи, белый или оранжевый внутри. Белый снаружи, белый или оранжевый внутри.

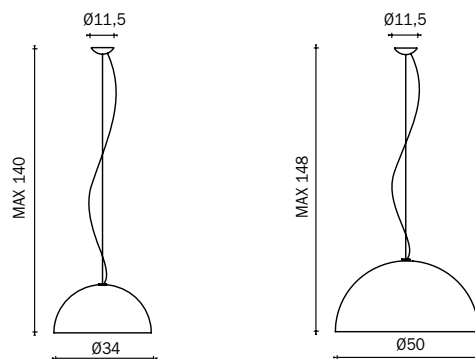

Sospensione - Pendant S1

CE V A IP20 P3

1x18W E27 DS GLOBE

1x15W E27 DS MINI GLOBE

Sospensione - Pendant S2

CE V A IP20 P3

1x18W E27 DS GLOBE

	ELECTR.	SOCKET	LAMP	CODE	FINISHING
--	---------	--------	------	------	-----------

SOSPENSIONE PENDANT S1	1x70W	E27	A55	T286	16 - 07 - 15 - 06
------------------------	-------	-----	-----	------	-------------------

SOSPENSIONE PENDANT S2	1x105W	E27	A55	T287	16 - 07 - 15 - 06
------------------------	--------	-----	-----	------	-------------------

Finiture Finishings



16
Bianco/Bianco
White/White



07
Bianco/Arancio
White/Orange



15
Nero/Bianco
Black/White



06
Nero/Arancio
Black/Orange





ANKE



GINGER

design Lucente Lab

Lampade in tessuto disponibili nei colori avorio, rosso e nero.
Struttura metallica verniciata.

Lamps in fabric available in ivory, red and black. Painted metal structure.

Lampe en tissu disponible en couleur: ivoire, rouge ou noir. Structure vernis métallique.

Leuchte in den Farben elfenbein, rot und schwarz erhältlich. Struktur in lackiertem Metall.

Estructura metálica barnizada. Difusor en tejido rojo, negro y marfil.

Светильник из негорючей ткани песочного, красного или черного цветов. Крашеное металлическое основание.

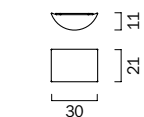

Parete - Wall A
CE E27 IP20 P3

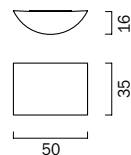

Parete - Wall A1
CE E27 IP20 P3

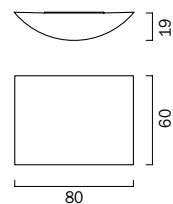

Parete - Wall A2
CE E27 IP20 P3

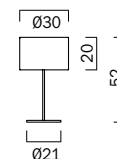

Tavolo - Table TA
CE E27 IP20 P3

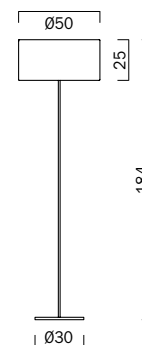

Terra - Floor TE
CE E27 IP20 P3

	ELECTR.	SOCKET	LAMP	CODE	FINISHING
PARETE WALL A	1x21W	E27	TC-TSE	T348	02 - 14
PARETE WALL A1	2x21W	E27	TC-TSE	T328	02 - 14
PARETE WALL A2	4x21W	E27	TC-TSE	T329	02 - 14
TAVOLO TABLE TA	1x70W	E27	A55	T265	02 - 14 - 15
TERRA FLOOR TE	1x105W	E27	A55	T266	02 - 14 - 15

Varianti tessuto
Fabric colour options

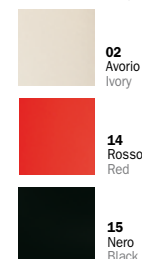

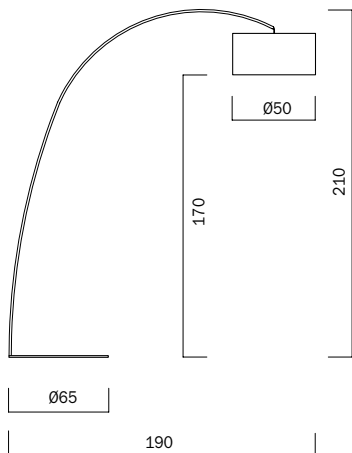

Terra arco - Floor arc

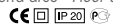

Soffitto - Ceiling P1

1x21W E27 TC-TSE

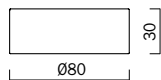

Soffitto - Ceiling P2

4x24W E27 TC-TSE

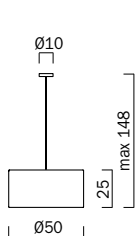

Sospensione - Pendant S1

1x21W E27 TC-TSE

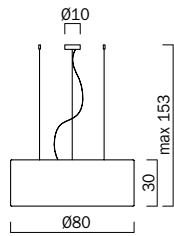

Sospensione - Pendant S2

4x24W E27 TC-TSE



PMMA decorato
Decorated PMMA

	ELECTR.	SOCKET	LAMP	CODE	FINISHING
SOFFITTO CEILING P1	1x105W	E27	A55	T261	02 - 14 - 15
SOFFITTO CEILING P2	4x42W	E27	A55	T262	02 - 14 - 15
SOSPENSIONE PENDANT S1	1x105W	E27	A55	T263	02 - 14 - 15
SOSPENSIONE PENDANT S2	4x42W	E27	A55	T264	02 - 14 - 15
TERRA FLOOR ARCO	1x105W	E27	A55	T285	02 - 14 - 15



PMMA bianco
White PMMA

	ELECTR.	SOCKET	LAMP	CODE	FINISHING
SOFFITTO CEILING P1	1x105W	E27	A55	T297	02 - 14 - 15
SOFFITTO CEILING P2	4x42W	E27	A55	T298	02 - 14 - 15
SOSPENSIONE PENDANT S1	1x105W	E27	A55	T299	02 - 14 - 15
SOSPENSIONE PENDANT S2	4x42W	E27	A55	T300	02 - 14 - 15
TERRA FLOOR ARCO	1x105W	E27	A55	T301	02 - 14 - 15

GINGER







GINGER



GINGER





GINGER





JAKI

design Lucente Lab

Serie in vetro soffiato con finitura lucida, disponibile nei colori bianco oppure rosso. Struttura metallica cromata per la versione a sospensione, parete e tavolo. Struttura metallica verniciata bianco opaco nella versione soffitto a 4 luci e soffitto con tige a 2 luci. Versione da parete IP44.

Range of blown glass lamps available in glossy white and red. Chrome metal structure on the pendant, wall and table lamp. On the 4-light and 2-light with rod ceiling versions the metal structure is matt white painted. IP44 rated wall lamp.

Série en verre soufflé avec une finition polie, disponible en blanc ou rouge. Monture en métal chromé pour les suspensions, appliques, et lampe de table. Pour la version plafonnier avec 4 lumières et plafonnier avec 2 tiges, la structure métallique est peint en blanc mat. IP44 pour la lampe murale.

Diffusor in geblasenem Glas in glänzender Ausführung, in den Farben Weiß und Rot.

Struktur aus verchromtem Metall für die Hängeleuchte, Wand und Tisch. Matt weiß lackiertem Metall Struktur in der Deckenleuchte mit 4 Leuchten und die Deckenleuchte mit starrem Schaft. Wandleuchte IP44.

Serie en vidrio soplado brillante, disponible en los colores blanco o rojo. Estructura metálica en cromo por la versión suspendida, de pared y sobremesa.





Estructura metálica barnizada blanco mate por la versión de techo a cuatro luces y por la versión de techo a dos luces con asta. Lámpara de pared IP44.

Плафоны, выполненные из дутого блестящего стекла, могут быть белого или красного цвета.

Металлическое основание хромировано у подвесных, настольных и настенных моделей.

Металлическое основание окрашено в белый матовый цвет у потолочной модели с 4-мя плафонами и подвесной версии с 2-мя плафонами. Бра имеет защиту IP44.



	ELECTR.	SOCKET	LAMP		CODE	FINISHING
PARETE WALL	1x33W	G9	QT-13		T322	14 - 16
SOSPENSIONE PENDANT	1x105W	E27	A55		T319	14 - 16
SOFFITTO CON TIGE CEILING WITH ROD	2x33W	G9	QT-13		T320	14 - 16
SOFFITTO CEILING	4x33W	G9	QT-13		T321	14 - 16
TAVOLO TABLE	1x48W	G9	QT-13		T323	14 - 16

Varianti vetro

Glass colour options



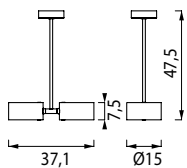

Soffitto con tige
Ceiling with rod
CE

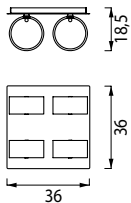

Soffitto - Ceiling
CE

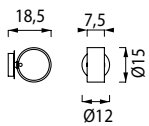

Parete IP44 - Wall IP44
CE

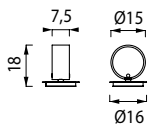

Tavolo - Table
CE

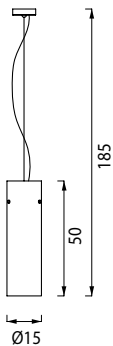

Sospensione - Pendant
CE



JAKI





JAKI





Lampada da soffitto e sospensione in metallo verniciato nei colori bianco lucido, verniciato rame e verniciato nero antracite. Diffusore inferiore diffondente in PMMA opale. Alimentazione elettronica.

Painted metal pendant and ceiling lamps. Available finishes are glossy white, copper and anthracite black. Opal PMMA diffuser. Electronic ballast.

Plafonnière ou suspension en métal blanc brillant, noir anthracite et cuivre verni. Diffuseur inférieur en PMMA opale. Ballast électronique.

Metalstruktur erhältlich in den Farben Weiß Hochglanz lackiert, Kupfer und schwarz anthrazit lackiert. Der Diffusor in PMMA opal. Elektronische Stromversorgung.

Lámpara de techo y suspendida en metal barnizado en los colores blanco brillo, cobre y negro antracita. Difusor de PMMA mate. Ballast electrónico.

Металлический корпус может быть окрашен в следующие цвета: глянцевый белый, медный или черный антрацит. Матовый акриловый рассеиватель. Имеется встроенный электронный балласт.



Finiture
Finishings



	ELECTR.	SOCKET	LAMP	CODE	FINISHING
SOFFITTO/PARETE CEILING/WALL	1x55W	2GX13	T5c ○	T317	16 - 03 - 08
SOFFITTO/PARETE CEILING/WALL	40+22W	2GX13	T5c ○	T330	16 - 03 - 08
SOSPENSIONE PENDANT	1x55W	2GX13	T5c ○	T318	16 - 03 - 08
SOSPENSIONE PENDANT	40+22W	2GX13	T5c ○	T331	16 - 03 - 08

▲ curve fotometriche disponibili photometrics available

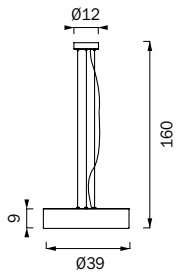

Sospensione - Pendant

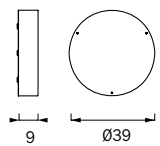

Soffitto/parete - Ceiling/wall

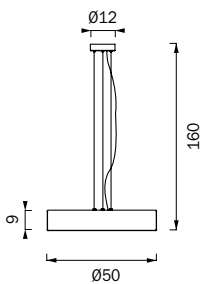

Sospensione - Pendant

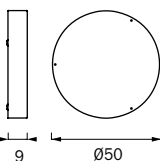

Soffitto/parete - Ceiling/wall



LEA





TAIA

design Lucente Lab

Lampade orientabili in metallo verniciato nero oppure argento. La lampada da parete è disponibile anche in finitura bianca.

Metal lamps with swivel head. Available in Grey and black. Wall light is also available in white finishing.

Lampes orientable en métal laqué, existe en noir ou gris. La version applique est disponible aussi laqué blanc.

Verstellbare Leuchten aus Metall in schwarz oder Silber gestrichen. Die Wandleuchte ist auch in weiß erhältlich.

Lámparas ajustables en metal pintado negro o plata. La lámpara de pared también está disponible en acabado blanco

Ориентируемые светильники из металла, окрашенного в черный или серебристый цвет. Настенный светильник может быть окрашен также и в белый цвет.



Finiture
Finishings



16
Bianco
White



15
Nero
Black



28
Argento
Silver

	ELECTR.	SOCKET	LAMP	CODE	FINISHING
PARETE WALL	1x42W	E14	P45	T349	15 - 16 - 28
TAVOLO TABLE	1x42W	E14	P45	T283	15 - 28
TERRA FLOOR	1x42W	E14	P45	T284	15 - 28

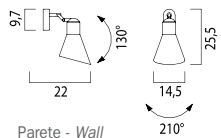

Parete - Wall

CE

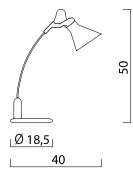

Tavolo - Table TA

CE

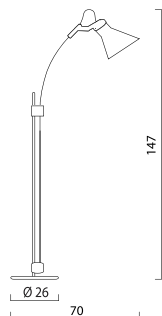

Terra - Floor TE

CE



TAIA





RANDA

design Lucente Lab

Base e riflettore in metallo verniciato, stelo in metallo cromato.

Painted metal base and reflector, chrome stem.

Base et réflecteur en métal laqué, tige en métal chromé.

Fuß und Reflektor aus lackiertem Metall, Ständer aus verchromtem Metall.

Base y reflector de metal barnizado, palo de metal cromado.

Окрашенное металлическое основание и отражатель Хромовая ножка.





Finiture
Finishings



15
Nero
Black



28
Grigio-argento
Silver Grey

	ELECTR.	SOCKET	LAMP	CODE	FINISHING
TAVOLO TABLE TA	1x42W	E14	P45 	P095	15 - 28
TERRA FLOOR TE	1x42W	E14	P45 	P096	15 - 28

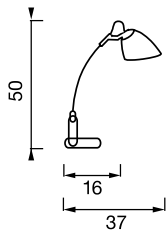

Tavolo - Table TA
 CE IP20 P

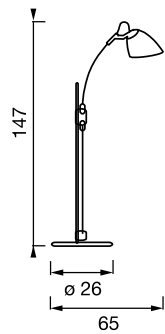

Terra - Floor TE
 CE IP20 P



OLYMPIA

design Roberto Favaretto

**Struttura in metallo verniciato grigio.
Diffusore in vetro soffiato satinato
bianco. Alimentazione elettronica.**

Grey painted metal fixture. Satin
blown glass diffuser available in white.
Electronic ballast.

Structure en métal verni gris.
Verre soufflé satiné blanc.
Ballast électronique.

Struktur aus Grau lackiertem Metall.
Streukörper aus mattem, geblasenem Weiss
Glas. Elektronische Stromversorgung.

Estructura en metal lacado gris.
Vidrio soplado satinado blanco.
Ballast electrónico.

Окрашенное металлическое основание.
Рассеиватель из дутого матового стекла
может быть белого цвета. Модели,
использующие энергосберегающие
лампы снабжены электронным
балластом.



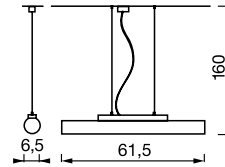

Sospensione - Pendant S1

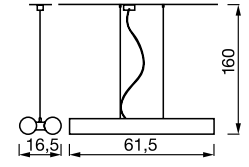

Sospensione - Pendant S2

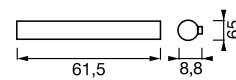

Parete - Wall A1

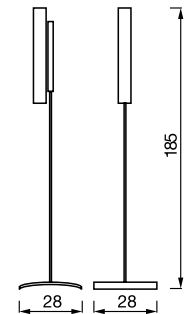
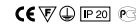

Terra - Floor TE-1



	ELECTR.	SOCKET	LAMP	CODE	FINISHING
SOSPENSIONE PENDANT S1	4x33W	G9	QT-13	T165	16
SOSPENSIONE PENDANT S1	1x24W	G5	T5	T166	16
SOSPENSIONE PENDANT S2	8x33W	G9	QT-13	T171	16
SOSPENSIONE PENDANT S2	2x24W	G5	T5	T172	16
PARETE WALL A1	4x33W	G9	QT-13	T167	16
PARETE WALL A1	1x24W	G5	T5	T168	16
TERRA FLOOR TE-1	4x33W	G9	QT-13	T169	16
TERRA FLOOR TE-1	1x24W	G5	T5	T170	16

curve fotometriche disponibili photometrics available

OLYMPIA





ZAC design Lucente Lab

**Struttura in metallo.
Diffusore in PMMA opalino.
Alimentazione elettronica.**

Metal structure. Opal PMMA satin acrylic diffuser. Electronic ballast.

Structure en métal. Diffuseur en PMMA opalin. Ballast électronique.

Struktur aus Metall. Weiss PMMA diffuser. Elektronische Stromversorgung.





Estructura de metal. Difusor en PMMA opalino. Ballast electrónico.

Металлическое основание в хроме или никеле. Матовый акриловый рассеиватель. Электронный балласт.

La serie è disponibile nella versione in emergenza da 1H o da 3H.

The range is available with emergency working 1H or 3H.



	ELECTR.	SOCKET	LAMP	CODE	FINISHING
SOFFITTO/PARETE CEILING/WALL P3	2x24W	2G11	TC-L 	T240	23 - 34
SOFFITTO/PARETE CEILING/WALL P3	2x24W	2G11	TC-L 	T275	16 - 28
SOFFITTO/PARETE CEILING/WALL P4	2x36W	2G11	TC-L 	T241	23 - 34
SOFFITTO/PARETE CEILING/WALL P4	2x36W	2G11	TC-L 	T276	16 - 28

 curve fotometriche disponibili photometrics available

Finiture Finishings



16
Bianco
White



23
Cromo
Chrome



28
Grigio-argento
Silver grey



34
Nichel spazzolato
Brushed nickel

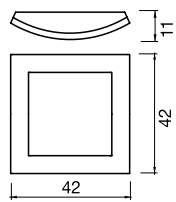

Parete/soffitto - Wall/ceiling P3

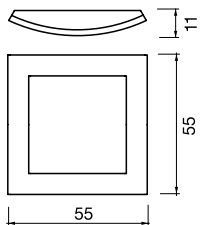

Parete/soffitto - Wall/ceiling P4







ZERO-EQUAL

design Roberto Favaretto

**Struttura in metallo, diffusore
in vetro serigrafato, cornici
disponibili in: bianco, grigio
verniciato, cromo lucido
e nickel spazzolato.
Alimentazione elettronica.**

Metal structure and silk-screened glass
diffuser. Frames available in: white
and grey painted, glossy chrome and
brushed nickel. Electronic ballast.

Structure en métal, diffuseur en verre
sérigraphié, cadres disponibles en:
blanc et gris laqué, chrome brillant et
nickel brossé. Ballast électronique.

Struktur aus Metall, Glasdiffusor
mit Siebdruck, Rahmen in: Weiß und
Grau lackiert, glänzend verchromt
und Nickel gebürstet. Elektronische
Stromversorgung.

Estructura de metal, difusor de vidrio
serigrafado, marcos disponibles en:
blanco o gris barnizado, cromo brillo y
níquel cepillado. Ballast electrónico.

Рассеиватель из стекла.
Металлический корпус белого
или серого цветов или в хrome
или никеле. Так же представлены
варианты с 1-часовым или
3-часовым аварийными режимами
работы. Электронный балласт.

**La serie è disponibile nella versione
in emergenza da 1H o da 3H.**

The range is available with emergency
working 1H or 3H.



ZERO

	ELECTR.	SOCKET	LAMP	CODE	FINISHING
SOFFITTO/PARETE CEILING/WALL L30	1x22W	2GX13	T5c	015253	Nickel spazzolato - Brushed nickel
SOFFITTO/PARETE CEILING/WALL L30	1x22W	2GX13	T5c	015252	Cromo - Chrome
SOFFITTO/PARETE CEILING/WALL L30	1x22W	2GX13	T5c	015251	Grigio - Grey
SOFFITTO/PARETE CEILING/WALL L30	1x22W	2GX13	T5c	015250	Bianco - White
SOFFITTO/PARETE CEILING/WALL L45	1x55W	2GX13	T5c	015257	Nickel spazzolato - Brushed nickel
SOFFITTO/PARETE CEILING/WALL L45	1x55W	2GX13	T5c	015256	Cromo - Chrome
SOFFITTO/PARETE CEILING/WALL L45	1x55W	2GX13	T5c	015255	Grigio - Grey
SOFFITTO/PARETE CEILING/WALL L45	1x55W	2GX13	T5c	015254	Bianco - White

curve fotometriche disponibili photometrics available

EQUAL

	ELECTR.	SOCKET	LAMP	CODE	FINISHING
SOFFITTO/PARETE CEILING/WALL L30	2x18W	2G11	TC-L	015288	Nickel spazzolato - Brushed nickel
SOFFITTO/PARETE CEILING/WALL L30	2x18W	2G11	TC-L	015289	Cromo - Chrome
SOFFITTO/PARETE CEILING/WALL L30	2x18W	2G11	TC-L	015290	Grigio - Grey
SOFFITTO/PARETE CEILING/WALL L30	2x18W	2G11	TC-L	015291	Bianco - White
SOFFITTO/PARETE CEILING/WALL L45	2x24W	2G11	TC-L	015292	Nickel spazzolato - Brushed nickel
SOFFITTO/PARETE CEILING/WALL L45	2x24W	2G11	TC-L	015293	Cromo - Chrome
SOFFITTO/PARETE CEILING/WALL L45	2x24W	2G11	TC-L	015294	Grigio - Grey
SOFFITTO/PARETE CEILING/WALL L45	2x24W	2G11	TC-L	015295	Bianco - White

curve fotometriche disponibili photometrics available

ZERO

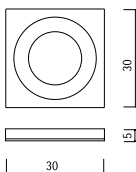

Parete/soffitto - Wall/ceiling L30

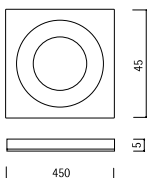

Parete/soffitto - Wall/ceiling L45



EQUAL

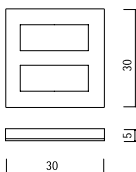

Parete/soffitto - Wall/ceiling L30

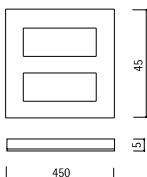

Parete/soffitto - Wall/ceiling L45



ZEN

design Roberto Favaretto

Struttura in metallo verniciato alluminio lucido. Diffusore in vetro curvato. Struttura metallica cromata o nickel spazzolato. Alimentazione elettronica.

Polished aluminium-painted metal structure. Curved glass diffuser. Chrome or brushed nickel metal structure. Electronic ballast.







Structure en métal peint aluminium brillant. Diffuseur en verre courbé. Structure métallique chromée ou nickel brossée. Ballast électronique.

Struktur aus hochglanzlackiertem oder vernickelte Metall in Aluminiumausführung. Rechteckiger Lichtverteiler aus geschwungenem Glas. Am Lichtverteiler angebrachte verchromte Metallstruktur. Elektronische Stromversorgung.

Estructura en metal lacado aluminio brillo. Difusor en vidrio curvado. Estructura aplicada al difusor en metal cromado o níquel cepillado. Ballast electrónico.

Металлическое основание. Гнущее стекло. Рамка в хроме или никеле. Электронный балласт.



	ELECTR.	SOCKET	LAMP	CODE	FINISHING
SOFFITTO CEILING L45	2x24W	2G10	TC-F 	013550	Cromo - Chrome
SOFFITTO CEILING L45	2x24W	2G10	TC-F 	013551	Nichel spazzolato - Brushed nickel
SOFFITTO CEILING L56	2x36W	2G10	TC-F 	013643	Cromo - Chrome
SOFFITTO CEILING L56	2x36W	2G10	TC-F 	013642	Nichel spazzolato - Brushed nickel
SOFFITTO/PARETE CEILING/WALL L16	1x36W	2G11	TC-L 	013545	Cromo - Chrome
SOFFITTO/PARETE CEILING/WALL L16	1x36W	2G11	TC-L 	013546	Nichel spazzolato - Brushed nickel

 curve fotometriche disponibili photometrics available

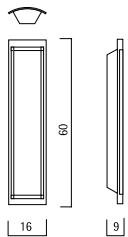

Soffitto/parete - Ceiling/wall L16
 CE

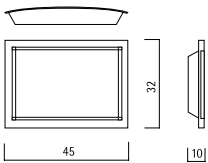

Soffitto - Ceiling L45
 CE

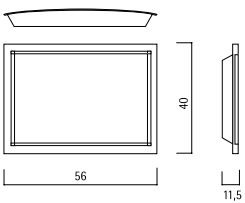

Soffitto - Ceiling L56
 CE



VISION

design Roberto Favaretto

Diffusore in doppio vetro curvato. Struttura metallica cromata o nickel spazzolato.

Double curved glass diffuser.
Chromed or brushed nickel metal structure.







Diffuseur à double verre courbé.
Structure métallique en métal chromé ou nickel brossé.

Rechteckiger Lichtverteiler aus doppeltem geschwungenem Glas.
An den Lichtverteilern angebrachte verchromte oder gebürstete und vernickelte.

Difusor con doble vidrio curvado.
Estructura metálica cromada o níquel cepillado.

Рассеиватели из гнутого стекла.
Металлическое основание в хроме или никеле.



	ELECTR.	SOCKET	LAMP	CODE	FINISHING
SOSPENSIONE PENDANT	1x120W	R7s 118mm	QT-DE 	009094	Cromo - Chrome
SOSPENSIONE PENDANT	1x120W	R7s 118mm	QT-DE 	013611	Nichel spazzolato - Brushed nickel
PARETE WALL	2x70W	E27	A55 	013588	Cromo - Chrome
PARETE WALL	2x70W	E27	A55 	013608	Nichel spazzolato - Brushed nickel
TERRA FLOOR	2x70W	E27	A55 	058580	Cromo - Chrome
TERRA FLOOR	2x70W	E27	A55 	013612	Nichel spazzolato - Brushed nickel

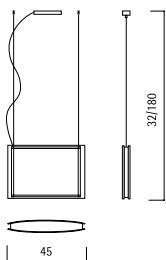

Sospensione - Pendant

CE IP30

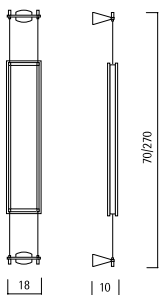

Parete - Wall

2x70W E27 QT-32/1x24W E27 TC-TSE

CE IP20

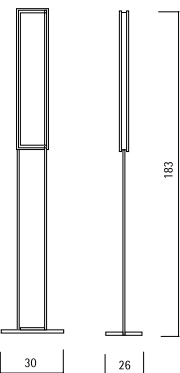

Terra - Floor

2x70W E27 QT-32

CE IP20



JAZZ

design Roberto Favaretto

Diffusore in vetro soffiato trasparente satinato. Struttura metallica cromata.

Satin transparent blown glass diffuser.
Chromed metal structure.

Diffuseur en verre soufflé transparent satiné. Structure métallique chromée.

Lichtverteiler aus geblasenem, transparentem, satiniertem Glas. Metallstruktur verchromt.

Difusor en vidrio soplado transparente satinado. Estructura metálica cromada.

Частично матированный плафон из дутого стекла. Металлическое основание в хроме.

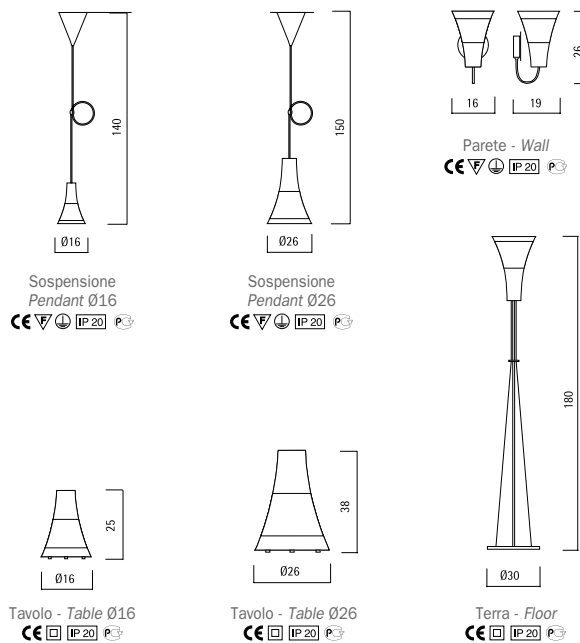

	ELECTR.	SOCKET	LAMP	CODE	FINISHING
PARETE WALL	1x42W	E14	P45	019596	Cromo - Chrome
SOSPENSIONE PENDANT Ø16	1x42W	E14	P45	019617	Cromo - Chrome
SOSPENSIONE PENDANT Ø26	1x70W	E27	A55	019597	Cromo - Chrome
TAVOLO TABLE Ø16	1x42W	E14	P45	019589	Cromo - Chrome
TAVOLO TABLE Ø26	1x70W	E27	A55	019588	Cromo - Chrome
TERRA FLOOR	1x205W	E27	QT-32	019598	Cromo - Chrome



JAZZ





Struttura in metallo verniciato con particolari di rotazione cromati. Riflettori in vetro bianco satinato.

Painted metal fixture and chrome details. Satin white glass diffuser.

Structure en métal verni avec des particuliers de rotation chromés. Réflecteurs en verre satiné blanc.

Die Reflektors sind schwenkbar. Struktur aus grau lackiertem Metall. Die Reflektorhalterungen sind aus verchromtem Metall.

Estructura de metal barnizado con detalles de rotación cromados. Reflectores de vidrio blanco satinado.

Окрашенное металлическое основание с хромированными деталями. Матовое стекло.

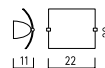

Parete - Wall L22
CE, V, IP20, P3

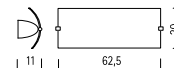

Parete - Wall L62
CE, V, IP20, P3

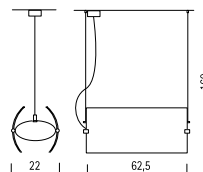



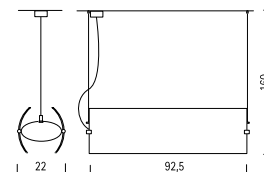

Sospensione - Pendant L62
CE, V, IP20, P3

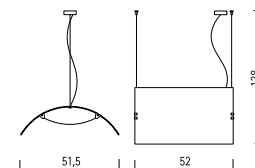

Sospensione - Pendant L92
CE, V, IP20, P3



Sospensione - Pendant Q
CE, V, IP20, P3

	ELECTR.	SOCKET	LAMP	CODE	FINISHING
PARETE WALL L22	1x80W	R7s 78mm	QT-DE 	017120	Grigio - Grey
PARETE WALL L62	1x24W	G5	T5 	017121	Grigio - Grey
SOSPENSIONE PENDANT Q	2x70W	E27	A55 	017125	Grigio - Grey
SOSPENSIONE PENDANT L62	2x24W	G5	T5 	017123	Grigio - Grey
SOSPENSIONE PENDANT L92	2x39W	G5	T5 	017124	Grigio - Grey



FLY





POSI POSI WAVE

design Roberto Favaretto

Struttura in metallo verniciato grigio. Diffusore in termoplastico serigrafato.

Grey painted metal structure.
Diffuser in screen-printed thermoplastic.

Structure en métal verni gris. Diffuseur en thermoplastique sérigraphié.

Struktur aus grau lackiertem Metall.
Lampenschirm aus Thermoplast mit Siebdruckmotiv.

Estructura en metal lacado gris.
Difusor en termoplástico serigrafiado.

Серое окрашенное металлическое основание. Рассеиватель из термопластика. Трафаретная печать.



	ELECTR.	SOCKET	LAMP		CODE	FINISHING
PARETE WALL A	1x70W	E27	A55		T029	28
SOSPENSIONE PENDANT S	2x70W	E27	A55		T026	28
TAVOLO TABLE TA	1x42W	E14	P45		T027	28
TERRA FLOOR TE	3x70W	E27	A55		T028	28
PARETE WALL W-A	1x70W	E27	A55		T195	28
SOSPENSIONE PENDANT W-S	2x70W	E27	A55		T196	28
TAVOLO TABLE W-TA	1x42W	E14	P45		T194	28
TERRA FLOOR W-TE	3x70W	E27	A55		T193	28

Varianti diffusore
Diffuser's options



POSI



POSI WAVE

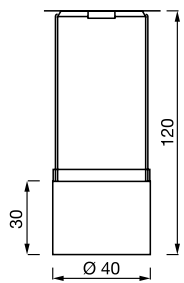

Sospensione - Pendant S
 CE IP20 P

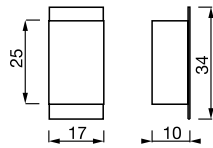

Parete - Wall A
 CE IP20 P

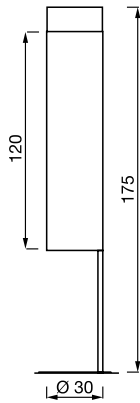

Terra - Floor TE
 CE IP20 P

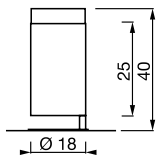

Tavolo - Table TA
 CE IP20 P



POSI WAVE





Struttura in metallo verniciato con particolari cromati. Diffusore in vetro soffiato satinato bianco. Alimentazione elettronica.

Painted metal structure with chrome details. White satin blown glass diffuser. Electronic ballast.

Structure en métal verni avec des particuliers chromés. Verre soufflé satiné blanc. Ballast électronique.

Struktur aus lackiertem Metall mit verchromten details. Geblasenem Weiß Glas. Elektronische Stromversorgung.

Estructura en metal lacado con detalles cromados. Difusor en vidrio soplado satinado blanco. Ballast electrónico.

Окрашенное металлическое основание с хромированными деталями. Белое матовое стекло. Электронный балласт.

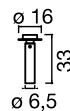

Soffitto - Ceiling P1
CE IP20 P3



Soffitto - Ceiling P2
CE IP20 P3

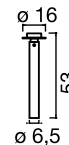

Soffitto - Ceiling P3
CE IP20 P3

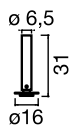

Tavolo - Table TA1
CE IP20 P3



Sospensione - Pendant S1
CE IP20 P3

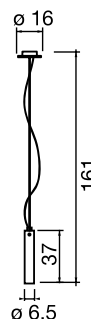

Sospensione - Pendant S2
CE IP20 P3





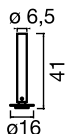





Sospensione - Pendant S3
CE IP20 P3



Tavolo - Table TA2
CE IP20 P3

	ELECTR.	SOCKET	LAMP	CODE	FINISHING
--	---------	--------	------	------	-----------

SOSPENSIONE PENDANT S1	1x18W	2G11	TC-L 	T221	16
SOSPENSIONE PENDANT S2	1x24W	2G11	TC-L 	T222	16
SOSPENSIONE PENDANT S3	1x36W	2G11	TC-L 	T223	16
SOFFITTO CEILING P1	1x18W	2G11	TC-L 	T218	16
SOFFITTO CEILING P2	1x24W	2G11	TC-L 	T219	16
SOFFITTO CEILING P3	1x36W	2G11	TC-L 	T220	16
TAVOLO TABLE TA1	1x48W	G9	QT-13 	T224	16
TAVOLO TABLE TA2	1x60W	G9	QT-14 	T225	16





OLLY



RHA

design Roberto Favaretto

**Struttura in alluminio pressofuso
verniciato grigio e vetro trasparente.
Riflettore orientabile.**

Grey painted die-cast aluminium structure
and clear glass diffuser. Adjustable reflector.

Structure en aluminium verni
et verre transparente. Réflecteur
et diffuseur orientable.

Struktur als grau lackiertem
Aluminium und Glas. Reflektor und
verstellbarer zylindrischer.

Estructura en aluminio lacado gris y vidrio
transparente. Reflector orientable.

Окрашенное в серый цвет алюминиевое
основание Прозрачное стекло
Настраиваемое направление света.



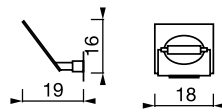

Parete - Wall A
 CE V IP20 P

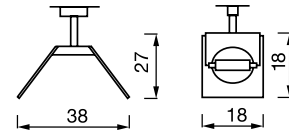

Soffitto - Ceiling P2
 CE V IP20 P

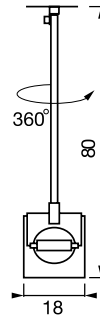

Soffitto - Ceiling P1
 CE V IP20 P

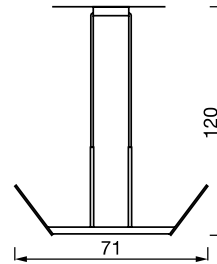

Sospensione - Pendant S2
 CE V IP20 P



Terra - Floor T1
 CE IP20 P

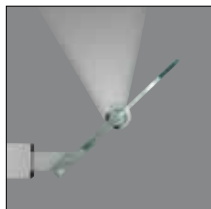

	ELECTR.	SOCKET	LAMP	CODE	FINISHING
PARETE WALL A	1x80W	R7s 78mm	QT-DE	T015	28
PARETE WALL AS	1x80W	R7s 78mm	QT-DE	T017	28
SOFFITTO CEILING P1	1x80W	R7s 78mm	QT-DE	T018	28
SOFFITTO CEILING P2	2x80W	R7s 78mm	QT-DE	T019	28
SOSPENSIONE PENDANT S2	2x80W	R7s 78mm	QT-DE	T021	28
TERRA FLOOR T1	1x80W	R7s 78mm	QT-DE	T023	28

RHA



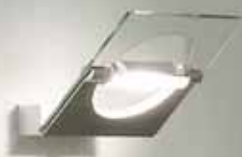





METI

design Roberto Favaretto

Struttura orientabile in alluminio pressofuso verniciato grigio. Vetro trasparente. Sospensione con tige regolabile in altezza.

Adjustable grey painted die-cast aluminium structure. Hanging lamp with height-adjustable chrome stem. Clear glass.

Structure en aluminium verni et verre transparente. Suspension avec tige réglable en hauteur, chromée.

Struktur aus lackiertem Aluminium und Glas. Hängeleuchte, höhenverstellbar verchromt.

Estructura en aluminio lacado gris. Vidrio transparente. Colgante con asta cromada ajustable.

Крашенный алюминий и прозрачное стекло.



	ELECTR.	SOCKET	LAMP		CODE	FINISHING
PARETE WALL A	1x60W	G9	QT-14	☛	T001	28
PARETE WALL A	1x50W	GU10	QPAR	☛	T002	28
SOFFITTO CEILING P	4x48W	G9	QT-13	☛	T003	28
SOFFITTO CEILING P	4x50W	GU10	QPAR	☛	T004	28
SOSPENSIONE PENDANT S	4x48W	G9	QT-13	☛	T005	28
SOSPENSIONE PENDANT S	4x50W	GU10	QPAR	☛	T006	28
TERRA FLOOR T	4x48W	G9	QT-13	☛	T010	28
TERRA FLOOR T	4x50W	GU10	QPAR	☛	T011	28

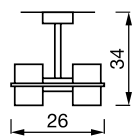

Soffitto - Ceiling P
 CE ⚡ IP30

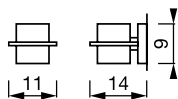

Parete - Wall A
 CE ⚡ IP30

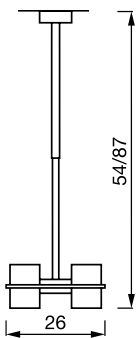

Sospensione - Pendant S
 CE ⚡ IP30

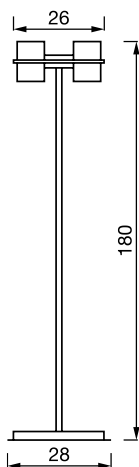

Terra - Floor T
 CE ⚡ IP30



METI





ALTEA

design Roberto Favaretto

**Diffusore in vetro soffiato satinato.
Struttura in metallo cromato
e verniciato. Filtri colorati
bianco, giallo e blu.**

Satin blown glass diffuser. Chrome and
aluminium painted metal structure. Filters
available in white, yellow and blue.





Diffuseur en verre soufflé satiné. Structure
en métal chromé et verni. Filtres teintés
disponibles en blanc, jaune et bleu.

Lampenschirm aus mattem, mundgeblasenem
Glas. Struktur aus verchromtem und
lackiertem Metall. Bunte Filter in den
Farben Weiß, Gelb und Blau.

Difusor en vidrio soplado satinado. Estructura
en metal cromado y barnizado. Filtros
colorados: blanco, amarillo y azul.

Матовое дутое стекло.
Металлическое хромовое основание
Фильтры белого, желтого и синего цвета.



	ELECTR.	SOCKET	LAMP		CODE	FINISHING
PARETE WALL A	1x42W	E27	A55		T115	23
SOSPENSIONE PENDANT S1	1x42W	E27	A55		T116	23
SOSPENSIONE PENDANT S2	1x70W	E27	A55		T117	23
TERRA FLOOR T	1x205W	E27	QT-32		T118	23

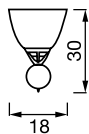

Parete - Wall A
 CE



Sospensione - Pendant S1
 Ø 18

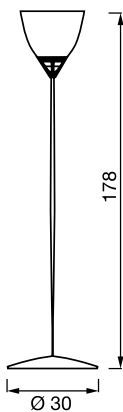

Sospensione - Pendant S2
 Ø 26

Terra - Floor T
 CE



ALTEA





LINA

design Roberto Favaretto

**Diffusore in vetro soffiato satinato.
Struttura in metallo verniciato grigio.**

Satin blown glass diffuser.
Grey painted metal structure.





Diffuseur en verre soufflé satiné.
Structure en métal verni gris.

Lampenschirm aus mattem, mundgeblasenem
Glas. Struktur aus Grau lackiertem.

Difusor en vidrio soplado satinado.
Estructura en metal barnizado gris.

Хромированное металлическое
основание. Матовое стекло.



	ELECTR.	SOCKET	LAMP		CODE	FINISHING
PARETE WALL A	1x42W	E27	A55		P076	01 - 16 - 43
SOSPENSIONE PENDANT S1	1x42W	E14	P45		P077	01 - 16 - 43
SOSPENSIONE PENDANT S2	1x70W	E27	A55		P078	16
TAVOLO TABLE TA	1x42W	E14	P45		P079	01 - 16 - 43
TERRA FLOOR TE	1x205W	E27	QT-32		P080	16

Varianti vetro
Glass colour options

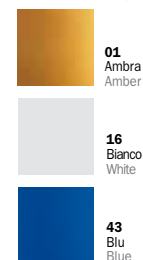

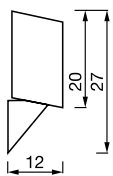

Parete - Wall A
 CE V IP20 P3

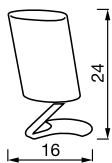

Tavolo - Table TA
 CE IP20 P3

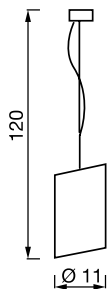

Sospensione - Pendant S1



Sospensione - Pendant S2

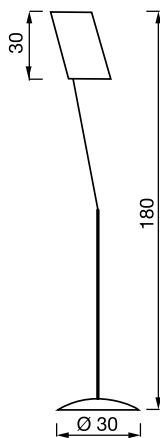
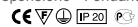

Terra - Floor TE
 CE IP20 P3



LINA





**Struttura in metallo verniciato grigio
e particolari cromati, diffusore
in vetro satinato bianco.**

Grey painted metal structure with chrome
details. White satin glass diffuser.

Structure en métal verni gris avec des
particuliers chromés. Diffuseur en verre
satiné opale.

Struktur aus Grau lackiertem Metall mit
verchromten details. Glass seidenmatt Opal.

Estructura en metal lacado gris con detalles
cromados. Difusor en vidrio satinado opal.

Окрашенное металлическое основание.
Рассеиватель из белого матового стекла.

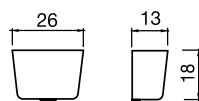

Parete - Wall A
CE E27 IP20 P3

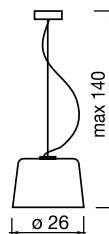

Sospensione - Pendant S
CE E27 IP20 P3

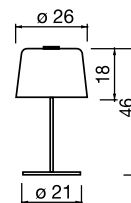

Tavolo - Table TA
CE E27 IP20 P3

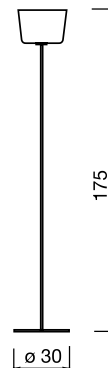

Terra - Floor TE
CE E27 IP20 P3

	ELECTR.	SOCKET	LAMP	CODE	FINISHING
PARETE WALL A	1x70W	E27	A55	T199	28
SOSPENSIONE PENDANT S	1x70W	E27	A55	T200	28
TAVOLO TABLE TA	1x60W	G9	QT-14	T198	28
TERRA FLOOR TE	1x205W	E27	QT-32	T197	28





EMY



INTERNOS

design Roberto Favaretto

Doppio diffusore in vetro satinato e curvato. Struttura metallica cromata o nickel spazzolato.

Double diffuser in satin glass. Chrome and brushed nickel metal structure.

Double diffuseur en verre satiné et courbé fixé sur une structure métallique chromée ou nickel brossée.

In eine verchromte oder vernickelte und gebürstete Metallstruktur eingesetzter doppelter Lichtverteiler aus bandförmig geschwungenem, satiniertem Glas.

Doble difusor en vidrio satinado curvado. Estructura metálica en níquel cepillado o cromada.

Рассеиватели из матового стекла. Основание в хrome или никеле.



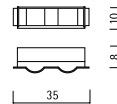

Parete - Wall L35
 CE V A IP20 P3

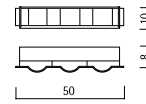

Parete - Wall L50
 CE V A IP20 P3

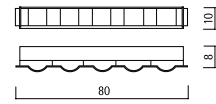

Parete - Wall L80
 CE V A IP20 P3

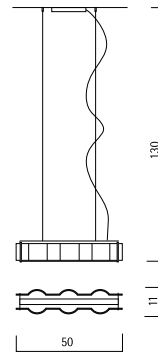

Sospensione - Pendant L50
 CE V A IP20 P3

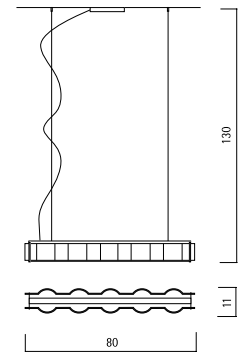

Sospensione - Pendant L80
 CE V A IP20 P3

	ELECTR.	SOCKET	LAMP	CODE	FINISHING
PARETE WALL L35	2x33W	G9	QT-13	013575	Cromo - Chrome
PARETE WALL L35	2x33W	G9	QT-13	013577	Nickel spazzolato - Brushed nickel
PARETE WALL L50	3x33W	G9	QT-13	013570	Cromo - Chrome
PARETE WALL L50	3x33W	G9	QT-13	013572	Nickel spazzolato - Brushed nickel
PARETE WALL L80	5x33W	G9	QT-13	013571	Cromo - Chrome
PARETE WALL L80	5x33W	G9	QT-13	013573	Nickel spazzolato - Brushed nickel
SOSPENSIONE PENDANT L50	3x33W	G9	QT-13	009085	Cromo - Chrome
SOSPENSIONE PENDANT L50	3x33W	G9	QT-13	009089	Nickel spazzolato - Brushed nickel
SOSPENSIONE PENDANT L80	5x33W	G9	QT-13	009092	Nickel spazzolato - Brushed nickel

curve fotometriche disponibili photometrics available



INTERNOS

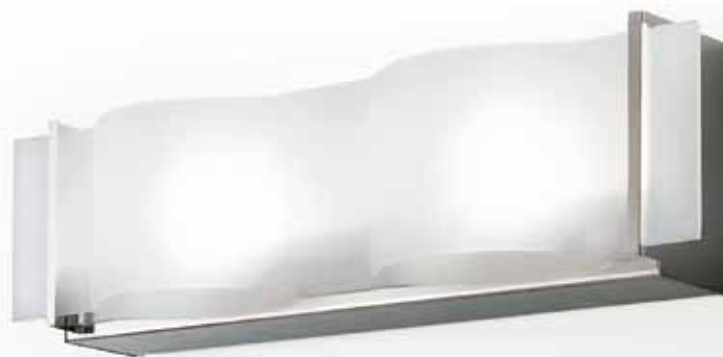

ELLA design Lucente Lab

Struttura in metallo verniciato grigio, diffusore in vetro satinato bianco, ambra o arancio.

Grey painted metal structure. Satin glass available in amber, opal and orange.



Support en métal verni gris. Diffuseur en verre satiné: opale, ambre et orange.

Armatur aus Grau lackiertem Metall. Glass seidenmatt Opal, Bernstein oder Orange.

Estructura en metal lacado gris. Difusor en vidrio satinado: opal, ámbar y anaranjado.

Окрашенное в серый цвет металлическое основание. Матовое стекло может быть белого, песочного или оранжевого цвета.



	ELECTR.	SOCKET	LAMP	CODE	FINISHING
PARETE WALL A	1x70W	E27	A55 	T149	01 - 04 - 16
SOSPENSIONE PENDANT S	1x70W	E27	A55 	T150	01 - 04 - 16
SOSPENSIONE PENDANT S2	1x70W	E27	A55 	T230	01 - 04 - 16

Varianti vetro Glass colour options



16
Bianco
White



01
Ambra
Amber



04
Arancio
Orange

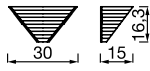

Parete - Wall A
 CE V A IP 20

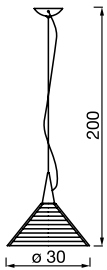

Sospensione - Pendant S
 CE V A IP 20

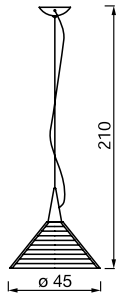

Sospensione - Pendant S2
 CE V A IP 20



ELLA





BELL

design Lucente Lab

Struttura in metallo verniciato e particolari cromati, vetro satinato: bianco, arancio, ambra e verde.

Painted metal structure. Satin glass diffusers available in white, orange, amber and green.

Structure en métal verni avec des particuliers chromés. Verres disponibles dans les couleurs blanc, orange, ambre et vert.

Struktur aus lackiertem Metall. Glass seidenmatt Opal, Bernstein, Orange oder Grün.

Estructura en metal lacado con detalles cromados. Difusor en vidrio satinado: opal, ámbar, naranja y verde.

Окрашенное металлическое основание
Матовые стеклянные плафоны могут быть белого, оранжевого, песочного и зеленого цвета.

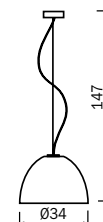

Sospensione - Pendant

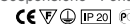

Varianti vetro

Glass colour options



16
Bianco
White



01
Ambra
Amber



04
Arancio
Orange



17
Verde
Green

SOSPENSIONE PENDANT

|ELECTR. | SOCKET | LAMP | CODE | FINISHING

1x70W E27 A55  T201 16 - 01 - 04 - 17



TASCA design Lucente Lab

Struttura in metallo verniciato nei colori bianco opaco e cor-ten.

Painted metal structure available in matt white and cor-ten.

Structure en métal verni blanc mat ou cor-ten.

Wandleuchte aus einem lackierten und gebogenen Metallblatt in der Form einer "Tasche". Verfügbar in den Farben Mattweiß oder Cor-ten.

Lámpara en metal barnizado en los colores blanco mate, y barnizado efecto cor-ten.

Корпус из металла.
Цвета: кортен, белый матовый.





Finiture Finishings



16
Bianco opaco
Matt white



11
Cor-ten

	ELECTR.	SOCKET	LAMP	CODE	FINISHING
PARETE WALL	1x26W	G24q-3 electr.	TC-DE 	T342	11 - 16
PARETE WALL	1x120W	R7s 118mm	QT-DE 	T343	11 - 16

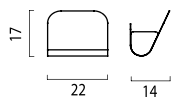

Parete - Wall

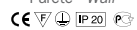

TRATTO

design Lucente Lab

Struttura in metallo cromato opaco. Diffusore in vetro soffiato opale satinato.

Mat chromed metal structure.
Opal satin blown glass diffuser.

Structure en métal chromé mat.
Diffuseur en verre soufflé opale satiné.

Struktur aus matt verchromtem Metall.
Lichtverteiler aus geblasenem,
satiniertem Opalglas.

Estructura en metal cromado opaco.
Difusor en vidrio soplado opal satinado.

Металлическое основание в хrome. Матовое дутое стекло белого цвета.



Parete - Wall L22
CE, IP20, P3



Parete - Wall L64
CE, IP20, P3

	ELECTR.	SOCKET	LAMP	CODE	FINISHING
PARETE WALL L22	1x120W	R7s 118mm	QT-DE	013589	Cromo opaco - Matt chrome
PARETE WALL L64	1x24W	G5	T5	013592	Cromo opaco - Matt chrome

curve fotometriche disponibili photometrics available



ECO design Roberto Favaretto

Riflettore frontale esterno in metallo nickel spazzolato e verniciato bianco all'interno. Alimentazione elettronica.

The metal reflector is brushed nickel outside and white painted inside.
Electronic ballast.

Réflecteur frontal extérieur en métal nickel brossé et laqué blanc à l'intérieur. Ballast électronique.

Frontreflektor außen aus Nickel gebürstetem Metall und innen weißlackiert. Elektronische Stromversorgung.

Reflector frontal exterior de metal níquel cepillado y pintado de blanco en la parte interior. Ballast electrónico.

Металлический отражатель никелирован с внешней стороны, а с внутренней - окрашен в белый цвет. Красный фильтр создает цветной световой эффект. Электронный балласт.

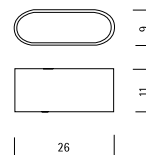

Parete - Wall L20

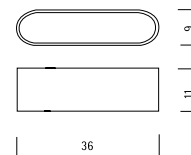



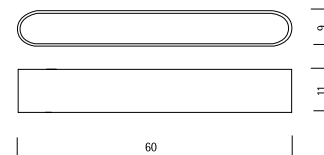

Parete - Wall L36

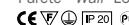

Parete - Wall L60



	ELECTR.	SOCKET	LAMP	CODE	FINISHING
PARETE WALL L26	1x80W	R7s 78mm	QT-DE 	015520	Nickel spazzolato - Brushed nickel
PARETE WALL L36	1x120W	R7s 78mm	QT-DE 	015522	Nickel spazzolato - Brushed nickel
PARETE WALL L36	1x26W	G24d-3	TC-D 	015521	Nickel spazzolato - Brushed nickel
PARETE WALL L60	1x36W	2G11	TC-L 	015526	Nickel spazzolato - Brushed nickel



AIN

design Roberto Favaretto

**Supporto in metallo cromato
o nickel spazzolato. Diffusore
in vetro satinato.**

Chrome or brushed nickel metal
support. Satin glass diffuser.

Support en métal chromé ou nickel
brossé. Diffuseur en verre satiné.

Halterung aus verchromtem oder
gebürstetem und vernickeltem Metall.
Lichtverteiler aus satiniertem Glas.

Soporte en metal cromado o níquel
cepillado. Difusor en vidrio satinado.

Металлическое основание в
хроме или никеле. Рассеиватель
из матового стекла.

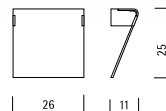

Parete - Wall L26
CE V A IP20 P

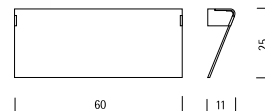

Parete - Wall L60
CE V A IP20 P

	ELECTR.	SOCKET	LAMP	CODE	FINISHING
PARETE WALL L26	1x120W	R7s 118mm	QT-DE	013580	Cromo - Chrome
PARETE WALL L26	1x120W	R7s 118mm	QT-DE	013597	Nickel spazzolato - Brushed nickel
PARETE WALL L26	1x26W	G24d-3	TC-D	013581	Cromo - Chrome
PARETE WALL L26	1x26W	G24d-3	TC-D	013598	Nickel spazzolato - Brushed nickel
PARETE WALL L60	2x80W	R7s 78mm	QT-DE	013584	Cromo - Chrome
PARETE WALL L60	2x80W	R7s 78mm	QT-DE	013601	Nickel spazzolato - Brushed nickel
PARETE WALL L60	1x36W	2G11	TC-L	013585	Cromo - Chrome
PARETE WALL L60	1x36W	2G11	TC-L	013602	Nickel spazzolato - Brushed nickel

curve fotometriche disponibili photometrics available



BRICK

design Roberto Favaretto

Struttura in metallo cromato o nickel spazzolato. Diffusori in vetro verniciato bianco. Alimentazione elettronica.

Chromed or brushed nickel metal structure. White painted glass diffusers. Electronic ballast.







Structure en métal chromé ou nickel brossé. Diffuseurs en verre opalin avec finition satinée. Ballast électronique.

Struktur aus verchromtem oder Nickel gebürstete Metall. Diffusoren aus Glas, satinierte Ausführung. Elektronische Stromversorgung.

Estructura en metal cromado o níquel cepillado. Doble difusor en vidrio opal satinado. Ballast electrónico.

Металлическое основание в хrome или никеле. Рассеиватель из стекла. Электронный балласт.



	ELECTR.	SOCKET	LAMP	CODE	FINISHING
PARETE WALL L20	1x80W	R7s 78mm	QT-DE 	015430	Cromo - Chrome
PARETE WALL L20	1x80W	R7s 78mm	QT-DE 	015431	Nickel spazzolato - Brushed nickel
PARETE WALL L29	1x26W	G24d-3	TC-D 	015436	Cromo - Chrome
PARETE WALL L29	1x26W	G24d-3	TC-D 	015437	Nickel spazzolato - Brushed nickel
PARETE WALL L49	1x36W	2G11	TC-L 	015438	Cromo - Chrome
PARETE WALL L49	1x36W	2G11	TC-L 	015439	Nickel spazzolato - Brushed nickel

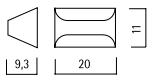

Parete - Wall L20

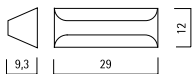

Parete - Wall L29

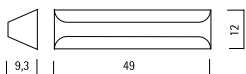

Parete - Wall L49



WALL design Lucente Lab

Lampade da parete con struttura in metallo verniciato disponibile nei colori: bianco lucido, grigio argento e rame. Diffusore PMMA opale. Struttura interna in metallo verniciato bianco.

Painted metal wall lamp available in glossy white, aluminium and copper. White painted back-plate. Opal PMMA diffuser.

Applique avec structure en métal. Disponible peint en blanc brillant, gris argent et cuivre. PMMA diffuseur opalin. Armature en acier intérieur peint en blanc.

Metalstruktur erhältlich in den Farben Weiß matt, Kupfer lackiert oder in silbergrau lackiert. Weiss PMMA diffuser.

Lámpara de pared con estructura de metal barnizado en los colores: blanco brillante, gris plata y cobre. Difusor de PMMA opalino. Estructura interior de metal barnizado blanco.

Настенный светильник. Металлический корпус может быть окрашен в следующие цвета: глянцевый белый, серебряный или медный. Матовый акриловый рассеиватель.



Finiture Finishings





16
Bianco
White



03
Rame
Copper



28
Grigio argento
Silver Grey

	ELECTR.	SOCKET	LAMP	CODE	FINISHING
PARETE WALL A1	1x24W	E27	TC-TSE 	T324	16 - 03 - 28
PARETE WALL A2	2x20W	E27	TC-TSE 	T325	16 - 03 - 28

 curve fotometriche disponibili photometrics available

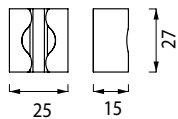

Parete - Wall A1
 CE V A IP20 E3

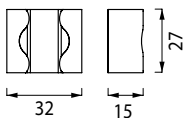

Parete - Wall A2
 CE V A IP20 E3



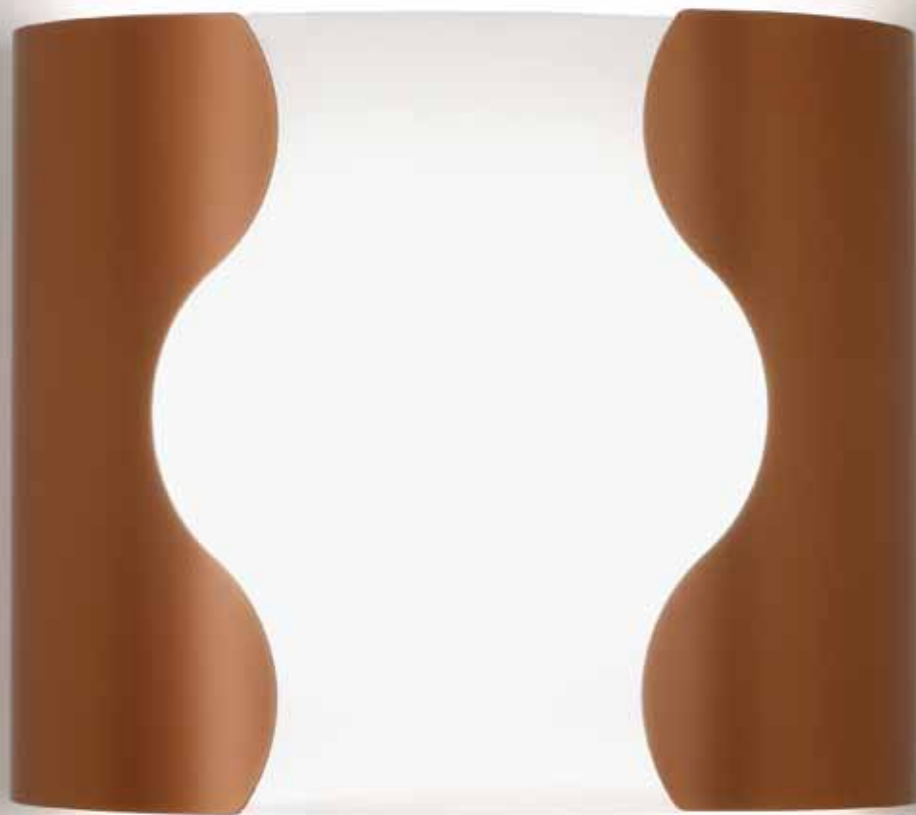

WALL



TWIST

design Roberto Favaretto

**Struttura in metallo verniciato grigio.
Diffusore curvato in vetro serigrafato
bianco. Alimentazione elettronica.**

Grey painted metal structure. Glass
diffuser. Electronic ballast.

Structure en métal verni gris.
Diffuseur en verre courbé sérigraphié
satiné. Ballast électronique.

Struktur aus Grau lackiertem Metall.
Glas seidenmatt, Siebdruck-Dekor.
Elektronische Stromversorgung.

Estructura en metal lacado gris.
Vidrio curvado serigrafiado satinado.
Ballast electrónico.

Окрашенное в серый цвет
основание. Рассеиватель из стекла,
электронным балластом.

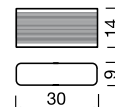

Parete - Wall A1
CE

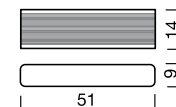

Parete - Wall A2
CE

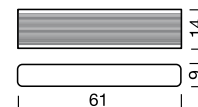

Parete - Wall A3
CE

	ELECTR.	SOCKET	LAMP	CODE	FINISHING
PARETE WALL A1	1x18W	2G11	TC-L	T315	28
PARETE WALL A1	1x70W	E27	QT-32	T203	28
PARETE WALL A2	1x36W	2G11	TC-L	T316	28
PARETE WALL A2	3x70W	E27	QT-32	T205	28
PARETE WALL A3	1x55W	2G11	TC-L	T206	28
PARETE WALL A3	4x70W	E27	QT-32	T207	28
PARETE WALL 4	2x18W	2G11	TC-L	T313	28
PARETE WALL 4	2x70W	E27	QT-32	T209	28
PARETE WALL 5	2x24W	2G11	TC-L	T314	28
PARETE WALL 5	2x70W	E27	QT-32	T211	28

curve fotometriche disponibili photometrics available

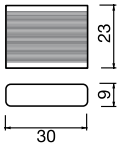

Parete - Wall 4



Parete - Wall 5



ASTRATTA

design Lucente Lab

Lampada da parete o soffitto in due dimensioni, diffusore in vetro in lastra extrachiaro con finiture serigrafate. Struttura interna in metallo verniciata bianca. Alimentazione elettronica.

Wall and ceiling lamps available in two sizes. Extraclear glass diffuser with screen-printed details. White painted inside metal frame. Electronic ballast.









Applique ou plafonnier en deux dimensions, diffuseur en verre tiré extra clair et finitions sérigraphies. Structure interne en métal verni blanc. Alimentation électronique.

Wand und Deckenleuchte lieferbar in zwei Größen. Die Glasscheibe hat eine bedruckte Verzierung. Weiß lackierter Metallrahmen. Inklusive elektronischem Vorschaltgerät.

Lampara de pared o techo en dos dimensiones, difusor en cristal extraclaro con acabado serigrafiado. Estructura interna en metal barnizado blanco. Alimentación electrónica.

Рассеиватель из стекла.
Электронный балласт.



	ELECTR.	SOCKET	LAMP	CODE	FINISHING
PARETE/SOFFITTO WALL/CEILING P1	2x28W	E27	A55 	T289	SASSI
PARETE/SOFFITTO WALL/CEILING P1	2x18W	G24q-2	TC-DE 	T290	SASSI
PARETE/SOFFITTO WALL/CEILING P2	2x42W	E27	A55 	T291	SASSI
PARETE/SOFFITTO WALL/CEILING P2	2x26W	G24q-3	TC-DE 	T292	SASSI
PARETE/SOFFITTO WALL/CEILING P1	2x28W	E27	A55 	T293	ONDA
PARETE/SOFFITTO WALL/CEILING P1	2x18W	G24q-2	TC-DE 	T294	ONDA
PARETE/SOFFITTO WALL/CEILING P2	2x42W	E27	A55 	T295	ONDA
PARETE/SOFFITTO WALL/CEILING P2	2x26W	G24q-3	TC-DE 	T296	ONDA

Varianti vetro
Glass options



SASSI



ONDA

ONDA

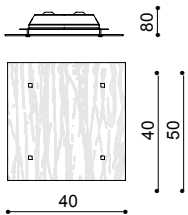

Parete/Soffitto - Wall/Ceiling P1

50

Parete/Soffitto - Wall/Ceiling P2



SASSI

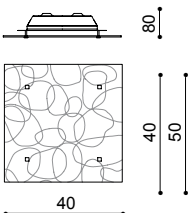

Parete/Soffitto - Wall/Ceiling P1

50

Parete/Soffitto - Wall/Ceiling P2

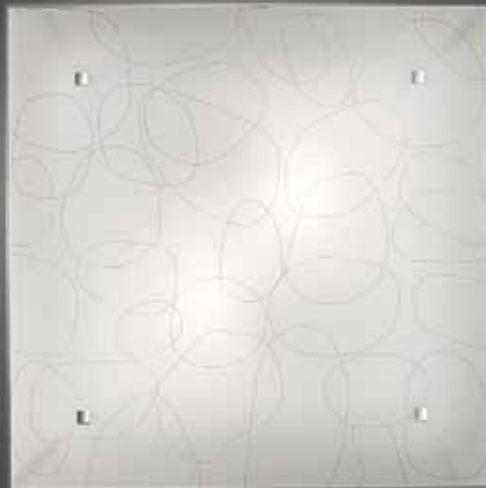

TRIM

design Lucente Lab

**Diffusore in vetro extrachiaro.
Struttura in metallo verniciata
bianca. Alimentazione elettronica.**

Extraclear glass diffuser. White
metal structure. Electronic ballast.







Diffuseur en verre extra clair. Structure
en métal blanc. Ballast électronique.

Glas und struktur in weiss lackiertem Metall.
Elektronische Stromversorgung.

Difusor en vidrio extraclaro. Estructura
metálica barnizada blanca.
Ballast electrónico.

Стекланный рассеиватель, белое
металлическое основание.
электронным балластом.



	ELECTR.	SOCKET	LAMP	CODE	FINISHING
PARETE WALL A1	1x26W	G24q-3	TC-DE 	T270	16
PARETE WALL A1	1x24W	E27	TC-TSE 	T281	16
PARETE WALL A2	1x36W	2G11	TC-L 	T271	16
PARETE WALL A2	2x24W	E27	TC-TSE 	T282	16
PARETE/SOFFITTO WALL/CEILING P1	2x42W	E27	A55 	T272	16
PARETE/SOFFITTO WALL/CEILING P1	2x26W	G24q-3	TC-DE 	T273	16

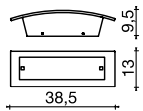

Parete - Wall A1

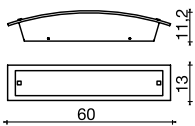

Parete - Wall A2

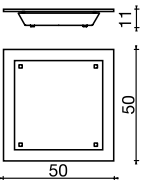

Parete/soffitto - Wall/ceiling P1



BOREALE

design Roberto Favaretto

Struttura in metallo verniciato grigio, vetro soffiato trasparente. Diffusore interno in vetro satinato o termoplastico opale. Alimentazione elettronica.

Grey painted metal structure, clear blown glass. Internal diffuser in satin glass or opal thermoplastic. Electronic ballast.

Structure en métal verni gris, verre soufflé transparent. Diffuseur interne en verre satiné ou thermoplastique opale. Ballast électronique.

Struktur aus grau lackiertem Metall und mundeblasenem Glas. Interner Lampenschirm aus Mattglas oder mattem Thermoplast. Elektronische Stromversorgung.

Estructura en metal lacado gris y vidrio soplado transparente. Vidrio interno satinado arenado o termoplástico blanco. Ballast electrónico.

Окрашенное в серый цвет металлическое основание. Прозрачное дутое стекло. электронным балластом.



	ELECTR.	SOCKET	LAMP		CODE	FINISHING
SOFFITTO CEILING T3	1x80W	R7s 78mm	QT-DE		T060	28
SOFFITTO CEILING T4	1x120W	R7s 118mm	QT-DE		T061	28
SOFFITTO CEILING 03	1x16W	GR8	TC-DD		T062	28
SOFFITTO CEILING 03	2x9W	2G7	TC-SE electr.		T303	28
SOFFITTO CEILING 04	1x28W	GR8	TC-DD		T064	28
SOFFITTO CEILING 04	1x26W	G24q-3	TC-DE electr.		T304	28

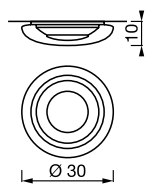

Soffitto - Ceiling T3
 CE V A IP20 E37

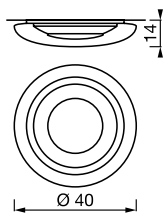

Soffitto - Ceiling T4
 CE V A IP20 E37

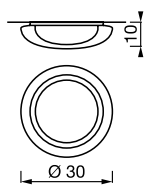

Soffitto - Ceiling O3
 CE V A IP20 E37

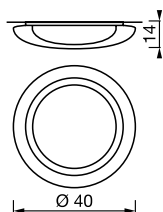

Soffitto - Ceiling O4
 CE V A IP20 E37



ARGO

design Lucente Lab

Lampada da parete in metallo verniciato e diffusore in vetro curvato bianco. Disponibile anche con gruppo di emergenza autonomo 1H. Alimentazione elettronica.

Wall lamp. Painted metal structure, white satin glass. Available with 1H emergency pack. Electronic ballast.



Applique en métal verni, diffuseur en verre satin blanc. Disponible aussi avec groupe d'urgence autonome 1H. Ballast électronique.

Metall -Wandleuchte lackiert und Diffusor mit weissem Glas. Auch mit Notlichteinrichtung mit 1H Akkupack erhältlich. Elektronische Stromversorgung.

Lámpara de pared. Estructura metálica barnizada. Difusores en vidrio blanco. Disponible también como lámpara de seguridad con autonomía de 1h. Ballast electrónico.

Бра. Крашеное металлическое основание, белое матовое стекло. Есть вариант с аварийным освещением на 1 час. Электронный балласт.



	ELECTR.	SOCKET	LAMP	CODE	FINISHING
PARETE WALL	1x24W	2G11	TC-L	 T257	16
PARETE WALL	1x24W	2G11	TC-L emergency 1h	 T258	16

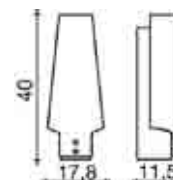

Parete - Wall
   



O-LAMP

design Roberto Favaretto

**Diffusore in vetro soffiato opale.
Base in pressofusione di alluminio.
Meccanismo di inserimento
e disinserimento del diffusore
trasparente in termoplastico.**

Satin opal blown glass diffuser with
clear thermoplastic ring for fixing
the base. Aluminium base.



Diffuseur en verre soufflé opale satiné.
Mécanisme de fixation et de élèvement
du globe en matériel thermoplastique
transparent. Base en aluminium.

Gebblasenem Opalglas. Aufsetz- und
Abnehmmechanismus der Kugel aus
transparentem thermoplastischen
Material. Struktur aus Aluminium.

Esfera en vidrio soplado opal satinado.
Mecanismo de fijación de la esfera
en termoplástico transparente.
Estructura en aluminio.

Матовое дутое стекло
Алюминиевое основание.



	ELECTR.	SOCKET	LAMP	CODE	FINISHING
PARETE/SOFFITTO WALL/CEILING	1x42W	E27	A55 	T152	28
TAVOLO TABLE	1x42W	E27	A55 	T153	28

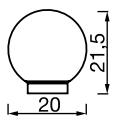

Tavolo - Table
CE

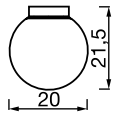

Parete/soffitto - Wall/ceiling
CE



GLEN

design Lucente Lab

Struttura in metallo verniciato nei colori: bianco e grigio argento. Alimentazione elettronica.

Painted metal structure in white or silver grey. Electronic ballast.



Structure métallique laquée blanc ou gris argent. Ballast électronique.

Basis aus Metall, lackiert weiß oder silbergrau. Elektronische Stromversorgung.

Estructura metálica en los colores blanco o gris plateado. Ballast electrónico.

Металлическое основание белого или серебряного цветов. Электронный балласт.



	ELECTR.	SOCKET	LAMP	CODE	FINISHING
PARETE WALL A1	1x160W	R7s 118mm	QT-DE 	T288	16 - 28
PARETE WALL A2	1x24W	T5	G5 	T326	16 - 28
PARETE WALL A3	1x39W	T5	G5 	T327	16 - 28

Finiture
Finishings



16
Bianco
White



28
Grigio-argento
Silver Grey

 curve fotometriche disponibili photometrics available

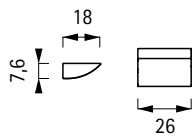

Parete - Wall A1
CE   IP20 

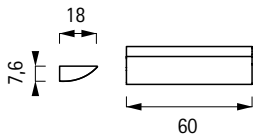

Parete - Wall A2
CE   IP20 

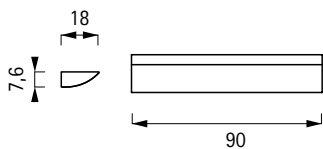

Parete - Wall A3
CE   IP20 





GLEN



Riflettore frontale in metallo verniciato bianco, cromo o nickel spazzolato. Jef A1, A2, A3 con doppio vetro di protezione temprato.

Metal reflector available in white painted, chrome or brushed nickel. Top and bottom tempered glass diffusers on Jef A1, A2 and A3.

Structure en métal vernie blanc, chrome brillant ou nickel brossé. Double diffuseur en verre pour la Jef A1, A2, A3.

Struktur aus Metall in weiss, glänzend verchromt oder Nickel geburstet. Doppel glas für Jef A1, A2, A3.

Reflector frontal de metal níquel cepillado, cromo o barnizado blanco. Jef A1, A2, A3 con doble vidrio de protección templado.

Металлическое основание в никеле, хроме или белого цвета В моделях JEF A1, A2, A3 рассеиватели из закаленного стекла.

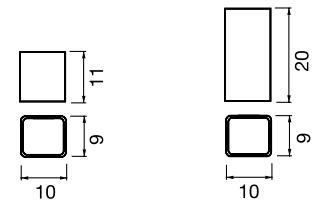

Parete - Wall 1
CE V A IP20 P37

Parete - Wall 2
CE V A IP20 P37



Parete - Wall A1
CE V A IP20 P37

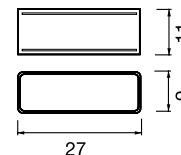

Parete - Wall A2
CE V A IP20 P37

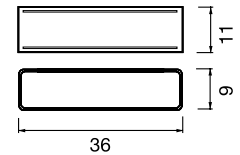

Parete - Wall A3
CE V A IP20 P37

Finiture
Finishings



16
Bianco
White



23
Cromo
Chrome



34
Nichel spazzolato
Brushed nickel

	ELECTR.	SOCKET	LAMP	CODE	FINISHING
PARETE WALL 1	1x75W	GU10	QPAR	T255	16 - 23 - 34
PARETE WALL 2	2x75W	GU10	QPAR	T256	16 - 23 - 34
PARETE WALL A1	1x48W	G9	QT-13	T252	16 - 23 - 34
PARETE WALL A2	1x80W	R7s 78mm	QT-DE	T253	16 - 23 - 34
PARETE WALL A3	1x26W	G24q-3 electr.	TC-DE	T309	16 - 23 - 34

curve fotometriche disponibili photometrics available







JEF





BAAN design Lucente Lab

Riflettore in acciaio AISI 430 satinato. Struttura in metallo verniciato. Alimentazione elettronica.

AISI 430 stainless steel reflector.
Painted metal structure. Electronic ballast.









Structure en métal verni. Réflecteur
de acier AISI 430. Ballast électronique.

Reflektor aus mattem Stahl AISI 430.
Struktur aus lackiertem Metall.
Elektronische Stromversorgung.

Reflector de acero satinado AISI 430.
Estructura de metal lacado.
Ballast electrónico.

Матовый отражатель из нержавеющей
стали. Окрашенное металлическое
основание. Электронный балласт.



	ELECTR.	SOCKET	LAMP	CODE	FINISHING
PARETE WALL LINEA-1	1x70W	E27	QT-32 	T277	25
PARETE WALL LINEA-1	1x26W	G24q-3	TC-DE 	T278	25
PARETE WALL FORI-1	1x70W	E27	QT-32 	T279	25
PARETE WALL FORI-1	1x26W	G24q-3	TC-DE 	T280	25
PARETE WALL LINEA-2	2x28W	E14	B35 	T175	25
PARETE WALL LINEA-2	1x24W	2G11	TC-L 	T176	25
PARETE WALL FORI-2	2x28W	E14	B35 	T177	25
PARETE WALL FORI-2	1x24W	2G11	TC-L 	T178	25

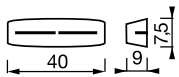

Parete - Wall LINEA-1



Parete - Wall FORI-1

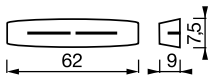

Parete - Wall LINEA-2

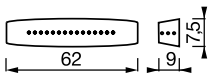

Parete - Wall FORI-2



**Struttura in metallo verniciato grigio
e schermo frontale in cromo lucido.
Disponibile senza o con vetro
sabbiato.**

Grey painted metal structure and chrome
front screen. To be provided with no glass
or with sanded glass diffuser.

Structure en métal verni gris et réflecteur
frontal en chrome brillant. Disponible dans la
version avec verre sablé ou sans verre.

Ausführung in grau lackiertem Metall und
vorderer Schirm glanzverchromt.
Mit seidenmattem Glas oder ohne.

Estructura de metal barnizado gris y
protección frontal cromada. Disponible en
versión con vidrio arenado o sin vidrio.

Окрашенное в серый и хромовый цвета
металлическое основание
Поставляется, как со стеклом,
обработанным пескоструйным способом,
так и без стекла.

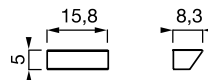

Parete - Wall A1
senza vetro - without glass
CE V A IP20 P-37

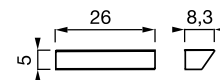

Parete - Wall A2
senza vetro - without glass
CE V A IP20 P-37

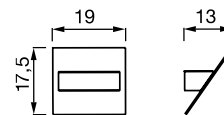



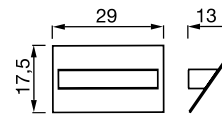

Parete - Wall A1
con vetro - with glass
CE V A IP20 P-37



Parete - Wall A2
con vetro - with glass
CE V A IP20 P-37

|ELECTR. | SOCKET | LAMP | CODE | FINISHING

PARETE senza vetro/WALL without glass A1	1x80W	R7s 78mm	QT-DE		T133	23
PARETE senza vetro/WALL without glass A2	1x120W	R7s 118mm	QT-DE		T135	23
PARETE con vetro/WALL with glass A1	1x80W	R7s 78mm	QT-DE		T132	23
PARETE con vetro/WALL with glass A2	1x120W	R7s 118mm	QT-DE		T134	23



HOT

design Lucente Lab

**Riflettore frontale in metallo
verniciato o cromo spazzolato.
Alimentazione elettronica.**

Metal reflector available
in painted or brushed chrome.
Electronic ballast.



Réflecteur frontal en métal disponible
dans les versions vernies ou en chrome
brossé. Ballast électronique.

Der vordere Metallreflektor ist lackiert
oder in gebürstetem Chrom erhältlich.
Elektronische Stromversorgung.

Reflector frontal de metal disponible
en versión barnizada o cromo cepillado.
Ballast electrónico.

Металлический отражатель представлен
в окрашенном сером цвете или в хроме.
Электронный балласт.



	ELECTR.	SOCKET	LAMP	CODE	FINISHING
PARETE WALL A1	1x80W	R7s 78mm	QT-DE 	T125	24 - 28
PARETE WALL A2	1x120W	R7s 118mm	QT-DE 	T126	24 - 28
PARETE WALL A3	1x24W	G5	T5 	T127	24 - 28

Finiture Finishings



24
Cromo spazzolato
Brushed chrome



28
Grigio-argento
Silver grey

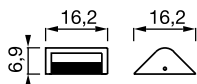

Parete - Wall A1

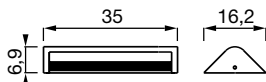

Parete - Wall A2

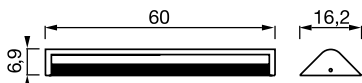

Parete - Wall A3



FLUONIGHT

design Lucente Lab

**Riflettore frontale orientabile
in metallo verniciato grigio
o cromato. Base in metallo
rigato verniciato grigio.**

Adjustable metal reflector available
in the grey painted or glossy chrome
versions. The fixture base is in grey
painted scored metal.





Applique orientable en métal disponible
dans la version verni gris ou chromée
brillante. La base de l'applique est
en métal rayé verni gris.

Vorderer Reflektor aus Metall, erhältlich
in grau lackierter in glänzend verchromter
Version. Der Fuß ist aus grau lackiertem
geriffeltem Metall.

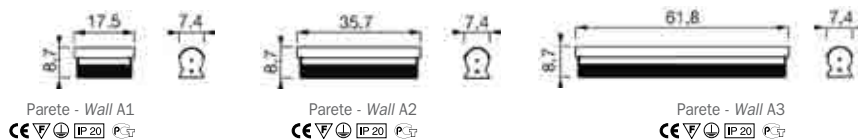
Reflector frontal orientable de metal
disponible en versión barnizada gris o
cromada brilla. La base del aparato es de
metal rayado barnizado gris.

Настраиваемый металлический
отражатель представлен в окрашенном
сером или глянцевом хромированном
цветах.



	ELECTR.	SOCKET	LAMP	CODE	FINISHING
PARETE WALL A1	1x80W	R7s 78mm	QT-DE 	T128	23 - 28
PARETE WALL A2	1x26W	G24d-3	TC-D 	T129	23 - 28
PARETE WALL A2	1x120W	R7s 118mm	QT-DE 	T130	23 - 28
PARETE WALL A3	1x36W	2G11	TC-L 	T131	23 - 28

Finiture
Finishings



23
Cromo
Chrome



28
Grigio-argento
Silver grey

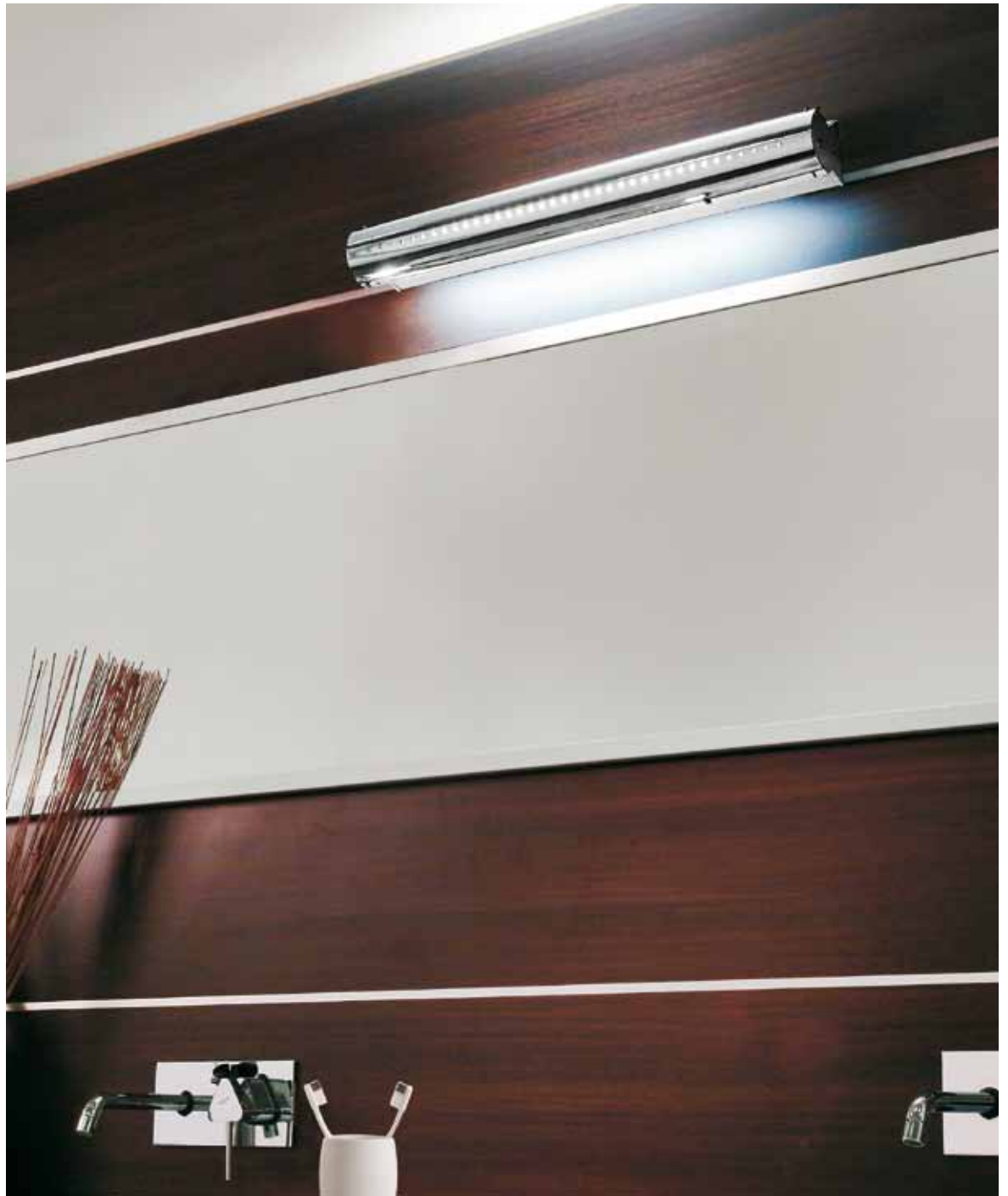

DOMINO

design Lucente Lab

**Supporto in metallo rigato
verniciato grigio e
diffusori in vetro satinato.**

Grey painted scored metal
structure. Satin glass diffuser.





Support en métal rayé verni gris
et diffuseurs en verre satiné.

Grau lackierten Metallhalterung und
Reflektoren aus seidenmattem Glas.

Soporte de metal rayado barnizado
gris y difusores de vidrio satinado.

Окрашенное в серый цвет
шероховатое металлическое основание
Матовое стекло.



	ELECTR.	SOCKET	LAMP	CODE	FINISHING
PARETE/SOFFITTO WALL/CEILING A1	1x48W	G9	QT-13 	T136	28
PARETE/SOFFITTO WALL/CEILING A2	2x48W	G9	QT-13 	T137	28
PARETE/SOFFITTO WALL/CEILING A3	3x48W	G9	QT-13 	T138	28
PARETE/SOFFITTO WALL/CEILING A4	1x70W	E27	A55 	T139	28
PARETE/SOFFITTO WALL/CEILING A4	1x24W	2G11	TC-L 	T140	28

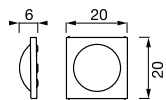

Parete/soffitto - Wall/ceiling A1
 CE V A IP30 P

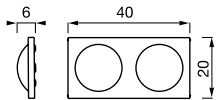

Parete/soffitto - Wall/ceiling A2
 CE V A IP30 P

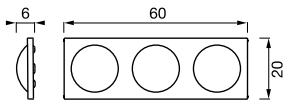

Parete/soffitto - Wall/ceiling A3
 CE V A IP30 P

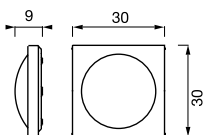

Parete/soffitto - Wall/ceiling A4
 CE V A IP30 P



BRIGHT

design Roberto Favaretto

**Struttura in metallo verniciato.
Diffusore in vetro bianco,
ambra, rosso e nero.
Alimentazione elettronica.**

Painted metal structure. Glass diffuser
available in white, amber, red and black.
Electronic ballast.

Structure en métal verni. Diffuseur en verre
coloré et satiné: blanc, ambre, rouge et noir.
Ballast électronique.

Struktur aus lackiertem Metall. Streukörper
aus mattem, farbigem Glas weiss,
bernsteinfarben, rot und schwarz erhältlich.
Elektronische Stromversorgung.

Estructura en metal lacado. Difusor
en vidrio blanco, ámbar, rojo y negro.
Ballast electrónico.

Окрашенное металлическое основание.
Рассеиватель из стекла представлен в
белом, песочном или черном цветах.
Электронный балласт.



Varianti vetro
Glass colour options



16
Bianco
White







01
Ambra
Amber



14
Rosso
Red



15
Nero
Black

	ELECTR.	SOCKET	LAMP	CODE	FINISHING
PARETE WALL A1	1x80W	R7s 78mm	QT-DE 	T179	16 - 01 - 14 - 15
PARETE WALL A2	1x120W	R7s 118mm	QT-DE 	T180	16 - 01 - 14 - 15
PARETE WALL A2	1x26W	G24q-3	TC-DE 	T305	16 - 01 - 14 - 15
PARETE WALL A3	1x36W	2G11	TC-L 	T306	16 - 01 - 14 - 15

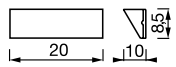

Parete - Wall A1
 CE V A IP 20 P 37

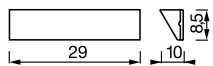

Parete - Wall A2
 CE V A IP 20 P 37

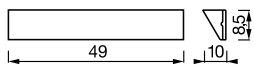

Parete - Wall A3
 CE V A IP 20 P 37

GAIA

design Roberto Favaretto

**Struttura in metallo verniciato.
Diffusore in vetro colore ambra con
finiture in bianco satinato. Diffusore
in vetro colore bianco con finiture a
scelta nei colori bianco, rosso e blu.**

Painted metal structure. Amber coloured
glass diffuser with satin white finishing.
White glass diffuser to be selected with
satin white, red and blue finishing.

Structure en métal verni. Verre coloré ambre
avec des finissages blancs satinés.
Verre blanc avec des finissages dans les
couleurs blanc, rouge et bleu au choix.

Struktur aus lackiertem Metall.
Streukörper aus bernsteinfarbenem Glas
mit Feinbearbeitung in mattem weiss.
Streukörper aus weissem Glas mit
Feinbearbeitung in weiss, rot und blau.

Estructura de metal lacado.
Vidrio de color ámbar con acabados
en blanco satinado. Vidrio blanco con
acabados de color blanco, rojo o azul.

Окрашенное металлическое основание.
Рассеиватель из стекла. Электронный
балласт в люминесцентной версии.
Рассеиватель из стекла. Электронный
балласт в люминесцентной версии.



Vetro ambra e finiture in bianco
Amber glass and white details

| ELECTR. | SOCKET | LAMP | CODE | FINISHING

PARETE WALL A1	1x80W	R7s 78mm	QT-DE		T183	16
PARETE WALL A1	1x18W	G24d-2	TC-D		T184	16
PARETE WALL A2	1x24W	2G11	TC-L		T185	16
PARETE WALL A3	1x36W	2G11	TC-L		T186	16



Vetro bianco e finiture colorate
White glass and coloured details

| ELECTR. | SOCKET | LAMP | CODE | FINISHING

PARETE WALL A1	1x80W	R7s 78mm	QT-DE		T187	14 - 16 - 43
PARETE WALL A1	1x18W	G24d-2	TC-D		T188	14 - 16 - 43
PARETE WALL A2	1x24W	2G11	TC-L		T189	14 - 16 - 43
PARETE WALL A3	1x36W	2G11	TC-L		T190	14 - 16 - 43

Finiture dettagli
Details finishings



16
Bianco
White



14
Rosso
Red



43
Blu
Blue

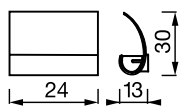

Parete - Wall A1
CE

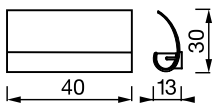

Parete - Wall A2
CE

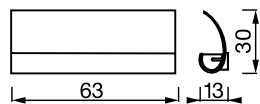

Parete - Wall A3
CE







SQUARE

design Lucente Lab

**Struttura in metallo verniciato.
Diffusore in vetro satinato.**

Painted metal structure.
Satin glass diffuser.

Structure en métal vernis.
Diffuseur en verre satiné.

Struktur aus lackiertem Metall.
Streukörper aus mattem Glas.

Estructura de metal lacado.
Vidrio satinado.

Окрашенное металлическое основание.
Рассеиватель из матового стекла.

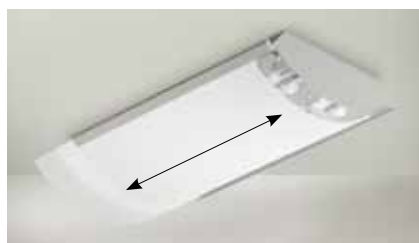

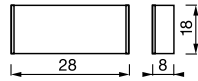

Parete/soffitto - Wall/ceiling 3

CE

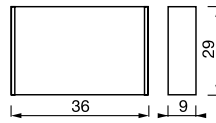

Parete/soffitto - Wall/ceiling 4

CE

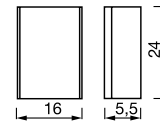

Parete/soffitto - Wall/ceiling 5

CE

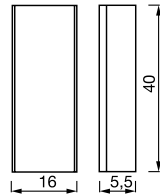

Parete/soffitto - Wall/ceiling 6

CE

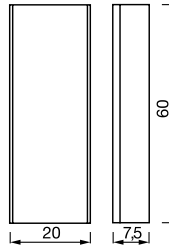

Parete/soffitto - Wall/ceiling 7

CE

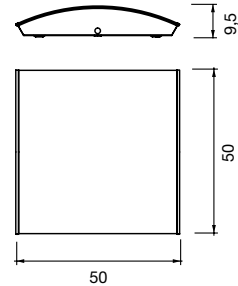

Parete/soffitto - Wall/ceiling 8

CE

	ELECTR.	SOCKET	LAMP	CODE	FINISHING
PARETE/SOFFITTO WALL/CEILING 3	1x42W	E27	A55	P030	16 - 28
PARETE/SOFFITTO WALL/CEILING 3	1x16W	GR8	TC-DD	P225	16 - 28
PARETE/SOFFITTO WALL/CEILING 3	2x18W	G24q-2	TC-DE electr.	P273	16 - 28
PARETE/SOFFITTO WALL/CEILING 4	2x42W	E27	A55	P031	16 - 28
PARETE/SOFFITTO WALL/CEILING 4	1x38W	GR10q	TC-DDE	P227	16 - 28
PARETE/SOFFITTO WALL/CEILING 4	2x36W	2G10	TC-F electr.	P274	16 - 28
PARETE/SOFFITTO WALL/CEILING 4	2x24W	2G10	TC-F emergency 1h	P242	16 - 28
PARETE/SOFFITTO WALL/CEILING 5	2x9W	2G7	TC-SE electr.	P275	16 - 28
PARETE/SOFFITTO WALL/CEILING 6	1x24W	2G11	TC-L electr.	P276	16 - 28
PARETE/SOFFITTO WALL/CEILING 7	2x36W	2G11	TC-L electr.	P277	16 - 28
PARETE/SOFFITTO WALL/CEILING 7	2x24W	2G11	TC-L emergency 1h	P246	16 - 28
PARETE/SOFFITTO WALL/CEILING 8	3x42W	E27	A55	P254	16 - 28
PARETE/SOFFITTO WALL/CEILING 8	3x36W	2G11	TC-L electr.	P278	16 - 28
PARETE/SOFFITTO WALL/CEILING 8	3x36W	2G11	TC-L emergency 1h	P256	16 - 28

curve fotometriche disponibili photometrics available

Finiture
Finishings



16
Bianco
White



28
Grigio-argento
Silver Grey

SQUARE





SAIL SAMURAI

design Poom Lab

**Struttura in termoplastico.
Diffusore in vetro satinato.**

Thermoplastic structure.
Satin glass diffuser.

Support en thermoplastique,
diffuseur en verre satiné.

Armatur aus Thermoplast,
Glas seidenmatt.

Estructura termoplástica.
Vidrio satinado.

Рассеиватель из матового стекла.

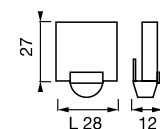

Parete - Wall SAIL
CE V A IP20 P3

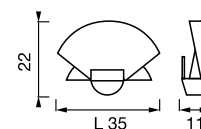

Parete - Wall SAMURAI
CE V A IP20 P3

	ELECTR.	SOCKET	LAMP		CODE	FINISHING
PARETE WALL SAIL	1x52W	E27	A55		P025	16
PARETE WALL SAIL	1x18W	G24d-2	TC-D		P238	16
PARETE WALL SAMURAI	1x52W	E27	A55		P026	16
PARETE WALL SAMURAI	1x18W	G24d-2	TC-D		P239	16



NUVOLA

design Lucente Lab

Struttura in termoplastico. Diffusore in vetro satinato.

Thermoplastic structure.
Satin glass diffuser.

Support en thermoplastique,
diffuseur en verre satiné.

Armatur aus Thermoplast,
Glas seidenmatt.

Estructura termoplástica.
Vidrio satinado.

Рассеиватель из матового стекла.

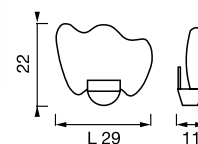

Parete - Wall

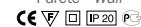

Varianti vetro
Glass colour options





16
Bianco
White



12
Giallo
Yellow



43
Blu
Blue

	ELECTR.	SOCKET	LAMP	CODE	FINISHING
PARETE WALL	1x52W	E27	A55 	P023	12 - 16 - 43
PARETE WALL	1x18W	G24d-2	TC-D 	P237	12 - 16 - 43

AIDA

design Lucente Lab

**Struttura in metallo
verniciato grigio.
Diffusore in vetro satinato.**

Grey painted metal structure.
Satin glass diffuser.

Structure en métal laqué gris,
diffuseur en verre satiné.

Armaturo aus Grau lackiertem Metall,
praegtes Glas seidenmatt.

Estructura en metal
barnizado gris. Vidrio satinado.

Окрашенное металлическое
основание. Матовое стекло.

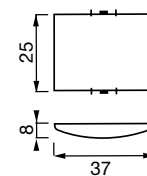

Soffitto - Ceiling P3

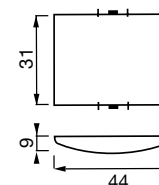

Soffitto - Ceiling P4



	ELECTR.	SOCKET	LAMP		CODE	FINISHING
SOFFITTO CEILING P3	2x28W	E14	P45		T090	28
SOFFITTO CEILING P3	1x80W	R7s 78mm	QT-DE		T091	28
SOFFITTO CEILING P4	2x42W	E27	A55		T092	28
SOFFITTO CEILING P4	1x120W	R7s 78mm	QT-DE		T093	28

KLYPTA

design Lucente Lab

Struttura in metallo verniciato grigio. Diffusore in vetro satinato nei colori ambra e bianco.

Grey painted metal plate.
Satin glass available in amber and white.

Structure en métal verni gris.
Diffuseur en verre satiné dans les couleurs:
opale et ambre.

Armatur aus Grau lackiertem Metall.
Glass seidenmatt Opal oder Bernstein.

Estructura en metal gris. Diffusor en
vidrio satinado ámbar y opal.

Металлическое окрашенное
крепление. Матовое стекло песочного
или белого цвета.

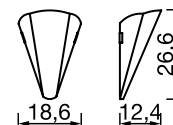

Parete - Wall



Varianti vetro
Glass colour options



16
Bianco
White

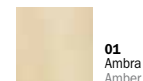

01
Ambra
Amber

	ELECTR.	SOCKET	LAMP	CODE	FINISHING
PARETE WALL A	1x70W	E27	A55	T151	01 - 16

JOLE

design Roberto Favaretto

**Diffusori in vetro satinato.
Supporto in metallo cromato.**

Satin glass diffuser.
Chrome metal structure.

Diffuseurs en verre satiné.
Support en métal chromé.



Reflektoren aus seidenmattem Glas.
Halterung aus verchromtem Metall.

Difusores en vidrio satinado.
Soporte de metal cromado.

Матовый рассеиватель из стекла
Окрашенное металлическое основание.



ELECTR.	SOCKET	LAMP	CODE	FINISHING
---------	--------	------	------	-----------

PARETE WALL A	1x42W	E14	P45	 T110	23
PARETE WALL A	1x80W	R7s 78mm	QT-DE	 T111	23

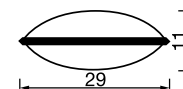

Parete - Wall
   IP40 

LUNA

design Lucente Lab

**Supporto in termoplastico,
reggivetri cromati o ottonati.
Diffusore in vetro satinato.**

Thermoplastic structure, chrome or brass-plated glass holders. Satin glass diffuser.

Support en thermoplastique, supports verre chromés ou laitonnés, diffuseur en verre satiné.

Armaturo aus Thermoplast, Glashalter verchromt oder mit Messingbeschichtung. Glas seidenmatt.

Soporte termoplástico, soportes del vidrio cromados o bronceados. Vidrio satinado.

Рассеиватель из матового стекла.

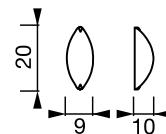

Parete - Wall 2
CE IP40

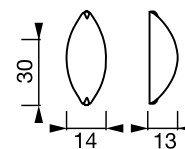

Parete - Wall 3
CE IP40

Finiture Finishings



22
Ottone
Brass



23
Cromo
Chrome

	ELECTR.	SOCKET	LAMP	CODE	FINISHING
PARETE WALL 2	1x28W	E14	P45	P081	22 - 23
PARETE WALL 3	1x42W	E27	A55	P082	22 - 23

STADIUM

design Lucente Lab

**Supporto in metallo verniciato.
Diffusore in vetro satinato.**

Painted metal structure.
Satin glass diffuser.

Support en métal laqué,
diffuseur en verre satiné.

Armaturo aus lackiertem Metall,
Glas seidenmatt.

Soporte de metal barnizado.
Vidrio satinado.

Рассеиватель из матового стекла.

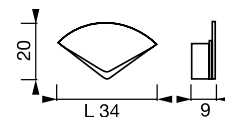

Parete - Wall

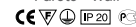

ELECTR. | SOCKET | LAMP | CODE | FINISHING

PARETE WALL | 1x42W | E27 | A55  | P013 | 16

ISOTTA

design Lucente Lab

**Base in metallo cromato e verniciato.
Diffusore in vetro soffiato satinato.**

Chrome plated and painted metal base.
Satin blown glass diffuser.

Diffuseur en verre soufflé satiné.
Base en métal chromé et laqué.

Gebblasenem Glas, Basis aus
verchromtem und lackiertem Metall.

Base de metal cromado y barnizado.
Vidrio soplado y satinado.

Металлическое основание
Рассеиватель из дутого матового стекла.



|ELECTR. | SOCKET | LAMP | CODE | FINISHING

TAVOLO TABLE

1x28W

E14

P45 

P085

16

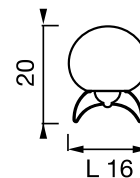

Tavolo - Table
CE  IP20 

EOS
IP44



design Roberto Favaretto

Struttura in metallo verniciato grigio. Diffusore in vetro soffiato opale satinato. Fissaggio del vetro a baionetta. IP44.

Grey painted metal structure. Opal satin blown glass. Twist-and-lock fixing. IP44.

Structure en métal verni gris, verre soufflé satiné opale. Fixation du verre à baïonnette. IP44.

Struktur aus Metall mit grauer Lackierung. Satiniertem, geblasenem Opalglas. Befestigung des Glases mit Bajonettverschluss. IP44.

Estructura en metal lacado gris y vidrio soplado opal satinado. Fijaje del vidrio a bayoneta. IP44.

Окрашенное в серый цвет металлическое основание
Матовое дутое стекло. IP44.

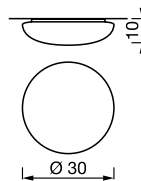

Parete/soffitto - Wall/ceiling P3

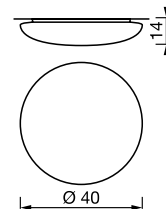

Parete/soffitto - Wall/ceiling P4



	ELECTR.	SOCKET	LAMP	CODE	FINISHING
PARETE/SOFFITTO WALL/CEILING P3	1x17W	dimmerable LED	3.000°K	T156	28
PARETE/SOFFITTO WALL/CEILING P3	1x16W	GR8	TC-DD	T154	28
PARETE/SOFFITTO WALL/CEILING P3	2x9W	2G7 electronic ballast	TC-SE	T307	28
PARETE/SOFFITTO WALL/CEILING P3	1x42W	E27	A55	T156	28
PARETE/SOFFITTO WALL/CEILING P4	1x28W	GR8	TC-DD	T157	28
PARETE/SOFFITTO WALL/CEILING P4	1x26W	G24q-3 electronic ballast	TC-DE	T308	28
PARETE/SOFFITTO WALL/CEILING P4	2x42W	E27	A55	T159	28

GRIFO

design Lucente Lab

IP44

Struttura in metallo verniciato alluminio. Diffusore in vetro soffiato opale satinato. Fissaggio del vetro a baionetta. Grado di protezione IP44. Alimentazione elettronica.

Aluminium painted metal structure. Opal satin blown glass. Twist-and-lock fixing. IP44 rated. Electronic ballast.

Structure en métal verni gris. Verre soufflé satiné opale. Fixation du verre à baïonnette. IP44. Ballast électronique.

Struktur aus Metall mit grauer Lackierung. Lichtverteiler aus geblasenem, satiniertem Opalglas. Bajonetteverschluss. IP44. Elektronische Stromversorgung.



Estructura en metal lacado gris y vidrio soplado opal satinado. Fisaje del vidrio a bayoneta. IP44. Ballast electrónico.

Алюминиевое основание. Белое матовое дутое стекло. Легкое крепление. IP44. Электронный балласт.



La serie è disponibile nella versione in emergenza da 1H o da 3H.

The range is available with emergency working 1H or 3H.

	ELECTR.	SOCKET	LAMP	CODE	FINISHING
PARETE/SOFFITTO WALL/CEILING	2x42W	E27	A55 	007570	Grigio - Grey
PARETE/SOFFITTO WALL/CEILING	2x26W	G24q-3	TC-DE 	007571	Grigio - Grey
PARETE/SOFFITTO WALL/CEILING	1x38W	GR10q	TC-DDE 	007572	Grigio - Grey

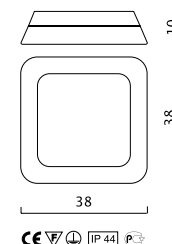

CE   



AI-PI INOX

IP54-AISI 304

design Roberto Favaretto

Struttura in acciaio inox AISI 304.
Diffusore in vetro masterpoint.
Fissaggio dell'anello a baionetta.
Grado di protezione IP 54.
Anche per installazioni esterne.

AISI 304 stainless steel collar. Master point glass. Twist-and-lock fixing. IP 54. Suitable also for outdoor application.

Structure métallique inox steel AISI 304. Verre master point. Fixation de la bague à baïonnette. IP 54. Indiqué aussi pour installations extérieures.

Struktur inox Stahl AISI 304. Masterpoint Glas. IP 54. Auch für Außenbereiche.

Estructura metálica en acero inox AISI 304. Vidrio masterpoint. Fijaje del anillo a bayoneta. IP 54. Adecuado para instalaciones exteriores.

Нержавеющая сталь. Стекло. IP 54. И для внешних установок.





Parete/soffitto - Wall/ceiling P1
 CE V IP54 P3

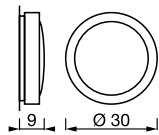

Parete/soffitto - Wall/ceiling P3
 CE V IP54 P3

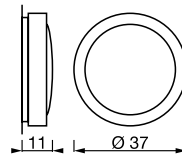

Parete/soffitto - Wall/ceiling P4
 CE V IP54 P3

	ELECTR.	SOCKET	LAMP	CODE	FINISHING
PARETE/SOFFITTO WALL/CEILING P1	1x33W	G9	QT-13	T148	25
PARETE/SOFFITTO WALL/CEILING P3	1x42W	E27	A55	T141	25
PARETE/SOFFITTO WALL/CEILING P3	1x16W	GR8	TC-DD	T142	25
PARETE/SOFFITTO WALL/CEILING P3	2x9W	G23	TC-S	T143	25
PARETE/SOFFITTO WALL/CEILING P4	2x42W	E27	A55	T144	25
PARETE/SOFFITTO WALL/CEILING P4	1x28W	GR8	TC-DD	T145	25
PARETE/SOFFITTO WALL/CEILING P4	1x26W	G24d-3	TC-D	T146	25
PARETE/SOFFITTO WALL/CEILING P4	1x18W	G24q-2 emergency 1h	TC-DE	T192	25

Finiture
 Finishings



25
 Acciaio satinato
 Satinated steel

curve fotometriche disponibili photometrics available

AI-PI
IP54

design Roberto Favaretto

Struttura metallica verniciata o galvanizzata. Diffusore in vetro acidato. Fissaggio dell'anello a baionetta. Grado di protezione IP 54. Solo per installazioni interne.

Collar available in white and aluminium painted, chrome and brushed nickel. Satin glass. Twist-and-lock fixing. IP 54. Only for indoor installation.

Structure métallique vernie Verre traité à l'acide. Fixation de la bague à baïonnette. IP 54. Indiqué seulement pour installations intérieures.

Struktur aus lackiertem oder galvanisiertem Aluminium. Milchglas. Befestigung des Bajonnettrings. IP 54. Nur für Installationen im Innenbereich gedacht.

Estructura metálica lacada o galvanizada. Vidrio satinado. Fijaje del anillo a bayoneta. IP 54. Adecuado sólo para instalaciones interiores.

Нержавеющая сталь. Стекло. IP 54. только для внутренних установок. Олько для внутреннего использования.





Parete/soffitto - Wall/ceiling P1

CE

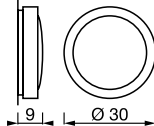

Parete/soffitto - Wall/ceiling P3

CE

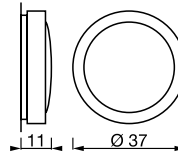

Parete/soffitto - Wall/ceiling P4

CE

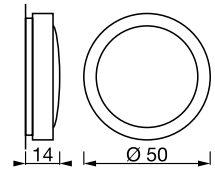

Parete/soffitto - Wall/ceiling P5

CE

	ELECTR.	SOCKET	LAMP	CODE	FINISHING
PARETE/SOFFITTO WALL/CEILING P1	1x33W	G9	QT-13	T147	16 - 23 - 28 - 34
PARETE/SOFFITTO WALL/CEILING P3	1x42W	E27	A55	T070	16 - 23 - 28 - 34
PARETE/SOFFITTO WALL/CEILING P3	1x16W	GR8	TC-DD	T071	16 - 23 - 28 - 34
PARETE/SOFFITTO WALL/CEILING P3	2x9W	G23	TC-S	T072	16 - 23 - 28 - 34
PARETE/SOFFITTO WALL/CEILING P4	2x42W	E27	A55	T075	16 - 23 - 28 - 34
PARETE/SOFFITTO WALL/CEILING P4	1x28W	GR8	TC-DD	T076	16 - 23 - 28 - 34
PARETE/SOFFITTO WALL/CEILING P4	1x26W	G24d-3	TC-D	T077	16 - 23 - 28 - 34
PARETE/SOFFITTO WALL/CEILING P4	1x18W	G24q-2 emergency 1h	TC-DE	T191	16 - 23 - 28 - 34
PARETE/SOFFITTO WALL/CEILING P5	3x42W	E27	A55	T231	16 - 28 - 34
PARETE/SOFFITTO WALL/CEILING P5	22+40W	2GX13 electronic ballast	T5-c	T232	16 - 28 - 34
PARETE/SOFFITTO WALL/CEILING P5	2x24W	2G11 electronic ballast	TC-L	T302	16 - 28 - 34
PARETE/SOFFITTO WALL/CEILING P5	2x24W	2G11 emergency 1h	TC-L	T234	16 - 28 - 34

Finiture
Finishings



16
Bianco
White



23
Cromo
Chrome



28
Grigio-argento
Silver grey



25
Nichel spazzolato
Brushed nickel

curve fotometriche disponibili photometrics available



AI-PI IP54



IDROO

IP54

design Lucente Lab

Lampade da parete e soffitto.
Struttura metallica verniciata
bianca, grigia oppure nera.
Diffusore in PMMA opale satinato.
Grado di protezione IP54.
Alimentazione elettronica.

Ceiling and wall lamps. Painted metal frame
 available in white, grey and black. Opal satin
 PMMA acrylic diffuser. IP 54 rated.
 Electronic ballast.

Applique/plafonn re, structure m tallique
 verni, blanc, gris ou noir. Diffuseur en PMMA
 opale satin e. Degr  de protection IP 54.
 Ballast  lectronique.

Wand und Deckenleuchte. Struktur in weiss,
 grau oder schwarz lackiertem Metall.
 Diffusor in PMMA opal satiniert. Schutzart
 IP 54. Elektronische Stromversorgung.



Estructura de metal barnizado blanco, gris o
 negro. Difusor de PMMA opalino. IP54
 Ballast electr nico.

Окрашенное в серый цвет
 металлическое основание
 Матовое дутое стекло. IP54.

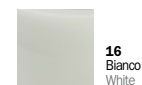
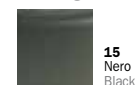

Finiture Finishings



	ELECTR.	SOCKET	LAMP	CODE	FINISHING
PARETE/SOFFITTO WALL/CEILING P1	1x21W	E27	TC-TSE 	T267	15 - 16 - 28
PARETE/SOFFITTO WALL/CEILING P1	1x26W	G24q-3	TC-DE 	T268	15 - 16 - 28
PARETE/SOFFITTO WALL/CEILING P2	2x24W	G5	T5 	T269	15 - 16 - 28

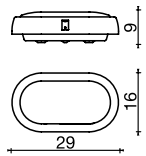

Parete/soffitto - Wall/ceiling P1

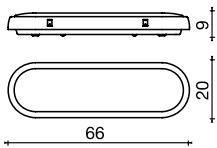

Parete/soffitto - Wall/ceiling P2



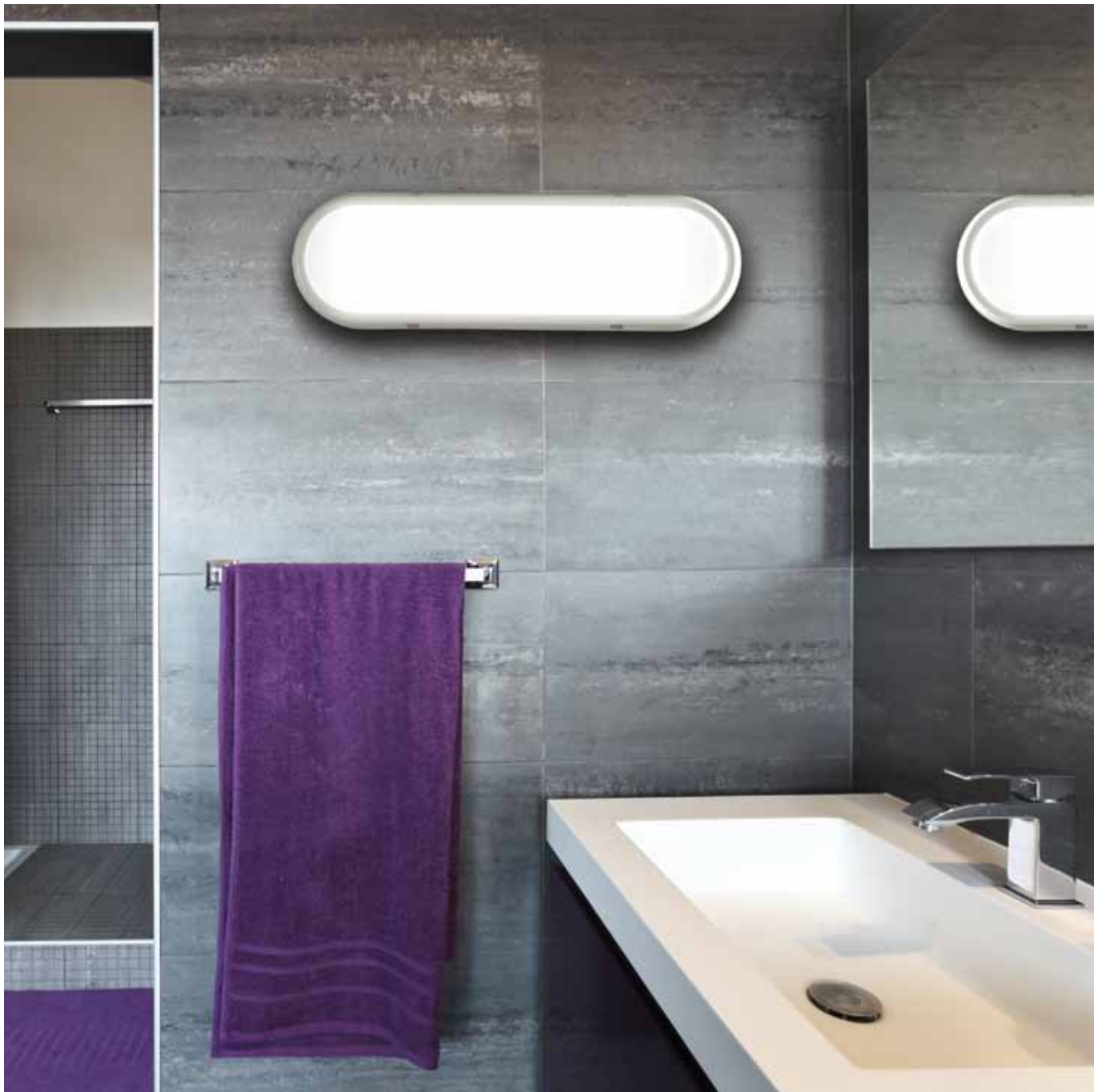

IDROO IP54



SQ-EASY

IP54

design Lucente Lab

Struttura in metallo verniciato,
diffusore in vetro stampato
satinato. IP54.

Painted metal structure.
White satin printed glass. IP54.

Structure en métal laqué, diffuseur
en verre satiné. IP54.

Lackiertem Metall, seidenmattes Glas. IP54.

Estructura de metal barnizado. Vidrio
imprimido satinado. IP54.

Окрашенное металлическое основание
Матовое стекло. IP54.

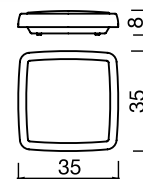

Parete/soffitto - Wall/ceiling P3



Finiture Finishings



16
Bianco
White



15
Nero
Black



28
Grigio-argento
Silver grey

ELECTR.	SOCKET	LAMP	CODE	FINISHING
PARETE/SOFFITTO WALL/CEILING P3	2x42W	E27	A55	T226 15 - 16 - 28
PARETE/SOFFITTO WALL/CEILING P3	2x18W	2G11	TC-L	T227 15 - 16 - 28
PARETE/SOFFITTO WALL/CEILING P3	1x28W	GR8	TC-DD	T229 15 - 16 - 28
PARETE/SOFFITTO WALL/CEILING P3	2x18W	2G11 electronic ballast	TC-L	T235 15 - 16 - 28
PARETE/SOFFITTO WALL/CEILING P3	2x11W	2G7 emergency 1h	TC-SE	T228 15 - 16 - 28



FLOAT

IP44

design Lucente Lab

Struttura in metallo cromato o nickel spazzolato. Grado di protezione IP44. Solo per installazioni interne.

Metal structure available in chrome and brushed nickel. IP44 rated. Only for indoor installation.

Structure en métal chromé ou nickel brossé. Degrés de protection IP44. Seulement pour installation intérieures.

Struktur in verchromtem oder nickel mattem Metall. Schutzart IP44. Nur für Installationen im Innenbereich gedacht.

Estructura en metal cromo brillo o niquel cepillado. IP44. Adecuado solo para instalaciones interiores.

Металлическое основание в никеле или хроме. IP44. Только для внутреннего использования.

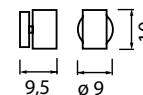

Parete - Wall A1
 CE V A IP44 P3

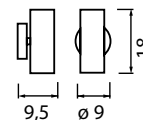

Parete - Wall A2
 CE V A IP44 P3

Finiture
 Finishings



23
 Cromo
 Chrome



34
 Nichel spazzolato
 Brushed nickel

	ELECTR.	SOCKET	LAMP	CODE	FINISHING
PARETE WALL A1	1x50W	GU10	QPAR	T259	23 - 34
PARETE WALL A2	2x35W	GU10	QPAR	T260	23 - 34

ONSEN

IP44

design Lucente Lab

Struttura in metallo cromo o nickel spazzolato. Vetro soffiato pirex. Grado di protezione IP44. Solo per installazioni interne.

Metal structure available in brushed nickel and chrome. Blown glass pyrex diffuser. IP44 rated. Only for indoor installation.

Structure en métal chrome brillant ou nickel brossé. Diffuseur en verre soufflé pyrex. IP44. Seulement pour installation intérieures.

Struktur aus Metall in glänzend verchromt oder Nickel geburstet. Weiss PMMA diffuser. Pirex geblasenem glas. IP 44. Nur für Installationen im Innenbereich gedacht.

Estructura en metal cromo brillo o níquel cepillado. Difusor en vidrio soplado pirex. IP44. Adecuado solo para instalaciones interiores.

Рассеиватель из жаростойкого стекла
Металлическое основание в никеле или хrome. IP 44. только для внутренних установок.

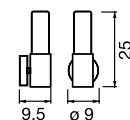

Parete - Wall A1
1x70W E27 QT-32
CE IP44

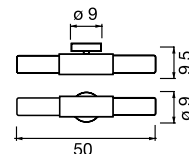

Parete - Wall A2
2x70W E27 QT-32
CE IP44



Vetro pirex decoro trasparente
Clear pyrex glass

	ELECTR.	SOCKET	LAMP	CODE	FINISHING
PARETE WALL A1T	1x17W	E27	TC-TSE	T245	34
PARETE WALL A2T	2x17W	E27	TC-TSE	T249	23 - 34



Vetro pirex decoro blu
Blue pyrex glass

	ELECTR.	SOCKET	LAMP	CODE	FINISHING
PARETE WALL A1B	1x17W	E27	TC-TSE	T247	34
PARETE WALL A2B	2x17W	E27	TC-TSE	T251	23 - 34

Finiture
Finishings



23
Cromo
Chrome



34
Nichel spazzolato
Brushed nickel

OSTER

IP44

design Lucente Lab

Diffusore in vetro. Utilizzabile nella versione semplice o con l'applicazione di una cornice in metallo verniciata o galvanizzata. IP44.

Glass difuser. Available as our standard and with collar in aluminium, yellow, orange painted and chrome. IP 44.

Verre satiné. Disponible dans la version simple ou avec un encadrement en métal verni ou galvanisé. IP44.

Glas seidenmatt. In einfacher Ausführung, oder mit galvanisiertem oder lackiertem Metallrahmen. IP44.

Difusor en vidrio. Se puede utilizar en la versión simple o aplicándole un marco de metal pintado o galvanizado. IP44.

Стекланный рассеиватель
Кольца представлены в алюминиевом, желтом, оранжевом или хромированном цветах. IP44.



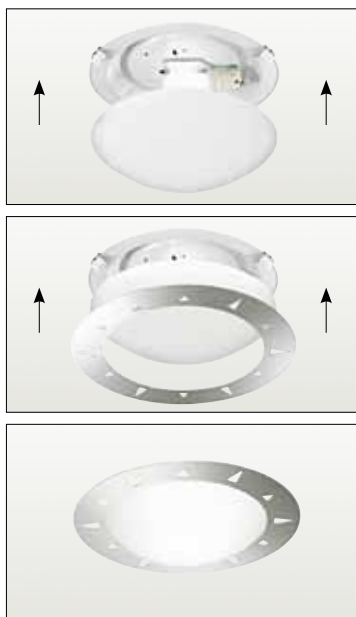

SENZA CORNICE WITHOUT METAL FRAME

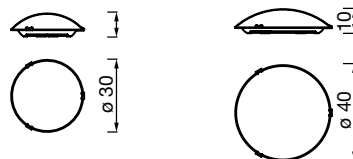

Parete/soffitto - Wall/ceiling P3

Parete/soffitto - Wall/ceiling P4



CON CORNICE WITH METAL FRAME

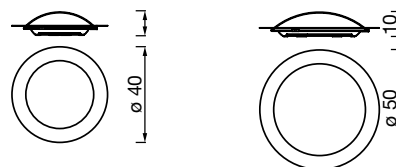

Parete/soffitto - Wall/ceiling P3

Parete/soffitto - Wall/ceiling P4



	ELECTR.	SOCKET	LAMP	CODE	FINISHING
PARETE/SOFFITTO WALL/CEILING P3	1x42W	E27	A55	P220	
PARETE/SOFFITTO WALL/CEILING P3	1x16W	GR8	TC-DD	P221	
PARETE/SOFFITTO WALL/CEILING P3	2x9W	G23	TC-S	P233	
PARETE/SOFFITTO WALL/CEILING P4	2x42W	E27	A55	P234	
PARETE/SOFFITTO WALL/CEILING P4	1x28W	GR8	TC-DD	P235	
PARETE/SOFFITTO WALL/CEILING P4	1x26W	G24d-3	TC-D	P236	



Comice decorativa in metallo decoro FIORI
Optional decorative FLOWER metal frame

	ELECTR.	SOCKET	LAMP	CODE	FINISHING
FIORI FLOWER P3		Ø40 cm		P217	04 - 12 - 23 - 28
FIORI FLOWER P4		Ø50 cm		P219	04 - 12 - 23 - 28



Comice decorativa in metallo decoro TRIANGOLI
Optional decorative TRIANGLE metal frame

	ELECTR.	SOCKET	LAMP	CODE	FINISHING
TRIANGOLO TRIANGLE P3		Ø40 cm		P216	04 - 12 - 23 - 28
TRIANGOLO TRIANGLE P4		Ø50 cm		P218	04 - 12 - 23 - 28

Finiture Finishings



04
Arancio
Orange



12
Giallo
Yellow



23
Cromo
Chrome



28
Grigio argento
Silver grey

HUT BIG HUT

Sospensione. Pendant lamp.

**Riflettore in metallo
colorato verniciato.**

Painted metal structure.

Diffuseur en métal laqué.

Armatur aus lackiertem Metall.

Reflector de metal
colorado y barnizado.

Металлический плафон.



HUT

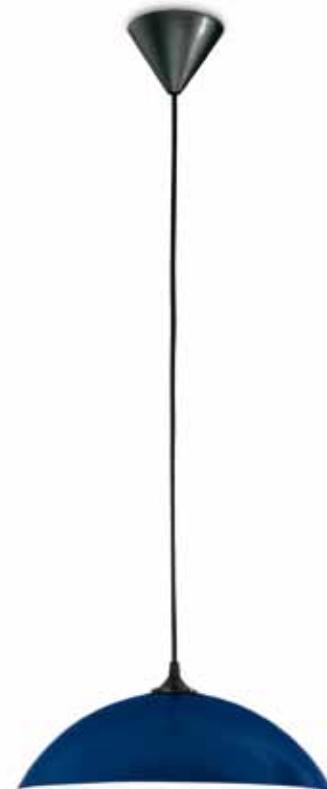

BIG HUT

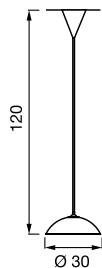

Sospensione - Pendant HUT

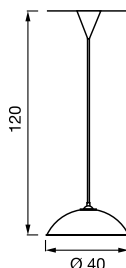
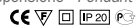

Sospensione - Pendant BIG HUT



Finiture
Finishings



14
Rosso
Red



16
Bianco
White



29
Alluminio
Aluminium



43
Blu
Blue

	ELECTR.	SOCKET	LAMP	CODE	FINISHING
SOSPENSIONE PENDANT HUT	1x52W	E27	A55	P050	14 - 16 - 29 - 43
SOSPENSIONE PENDANT BIG HUT	1x70W	E27	A55	P051	14 - 16 - 29 - 43

DIECIDIECI

Lampada da soffitto. Ceiling lamp. / Lampada da parete. Wall lamp.

Struttura metallica verniciata o galvanizzata. Diffusore in vetro satinato.

Metal frame available in white painted, chrome and brass. Satin glass diffuser.

Structure métallique vernie ou galvanisée. Verre satiné.

Struktur aus lackiertem oder galvanisiertem Metall. Glas seidenmatt.

Estructura metálica lacada o galvanizada. Vidrio satinado.

Кольца представлены в белом цвете, хrome или латуни
Матовое стекло.

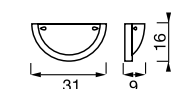

Parete - Wall A
CE V A IP20 P3

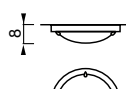

Soffitto - Ceiling P3
CE V A IP20 P3

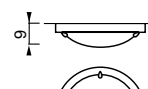

Soffitto - Ceiling P4
CE V A IP20 P3

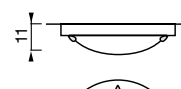

Soffitto - Ceiling P5
CE V A IP20 P3

|ELECTR. | SOCKET | LAMP | CODE | FINISHING

PARETE WALL A	1x42W	E27	A55		P012	16 - 22 - 23
PARETE WALL A	1x13W	G24d-1	TC-D		P022	16 - 22 - 23
SOFFITTO CEILING P3	1x42W	E27	A55		P010	16 - 22 - 23
SOFFITTO CEILING P3	2x9W	G23	TC-S		P020	16 - 22 - 23
SOFFITTO CEILING P3	1x16W	GR8	TC-DD		P105	16 - 22 - 23
SOFFITTO CEILING P4	2x42W	E27	A55		P011	16 - 22 - 23
SOFFITTO CEILING P4	1x28W	GR10q	TC-DDE		P021	16 - 22 - 23
SOFFITTO CEILING P5	2x42W	E27	A55		P261	16 - 22 - 23
SOFFITTO CEILING P5	2x26W	G24q-3 electronic ballast	TC-DE		P262	16 - 22 - 23
SOFFITTO CEILING P5	22+40W	2GX13 electronic ballast	T5c		P263	16 - 22 - 23
SOFFITTO CEILING P5	1x38W	GR10q electronic ballast	TC-DDE		P264	16 - 22 - 23

Finiture
Finishings



16
Bianco
White



22
Ottone
Brass



23
Cromo
Chrome

OMNI



Lampada da parete e soffitto. Wall and ceiling lamp.

Struttura in cromo spazzolato. Diffusore in vetro stampato satinato.

Collar in brushed nickel.
Satin glass diffuser.



Structure laqué en chrome brossé,
diffuseur en verre satiné.

Metallarmatur mit
bürsteten Chrombeschichtung,
seidenmattes Glas.

Estructura de cromo cepillado.
Vidrio imprimido satinado.

Никель Рассеиватель из
матового стекла.



	ELECTR.	SOCKET	LAMP	CODE	FINISHING
SOFFITTO CEILING	1x17W	dimmerable LED	3.000°K	T357	24
SOFFITTO CEILING	2x28W	E14	P45 	T109	24
SOFFITTO CEILING	1x38W	GR10q	TC-DDE 	T160	24
SOFFITTO CEILING	2x18W	G24d-2	TC-D 	T161	24

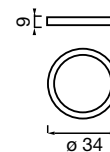

Soffitto - Ceiling



 curve fotometriche disponibili photometrics available

GALASSIA



Lampada da parete e soffitto. Wall and ceiling lamp.

Struttura metallica verniciata o galvanizzata. Diffusore in vetro satinato.

Collar available in white painted, chrome and brass. Satin glass diffuser.

Structure métallique vernie ou galvanisée. Verre satiné.

Struktur aus lackiertem oder galvanisiertem Metall. Glas seidenmatt.

Estructura metálica lacada o galvanizada. Vidrio satinado.

Кольца представлены в белом цвете, хроме или латуни
Матовое стекло.

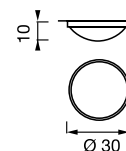

Soffitto - Ceiling 3
CE V A IP20 P3

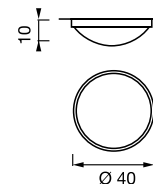

Soffitto - Ceiling 4
CE V A IP20 P3

Finiture
Finishings

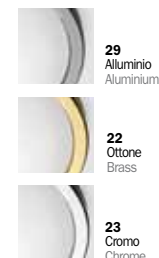

	ELECTR.	SOCKET	LAMP	CODE	FINISHING
SOFFITTO CEILING 3	1x17W	dimmerable LED	3.000°K	P279	22 - 23 - 29
SOFFITTO CEILING 3	1x52W	E27	A55	P099	22 - 23 - 29
SOFFITTO CEILING 4	2x42W	E27	A55	P100	22 - 23 - 29
SOFFITTO CEILING 4	1x28W	GR10q	TC-DDE	P223	22 - 23 - 29
SOFFITTO CEILING 4	2x26W	G24d-3	TC-D	P224	22 - 23 - 29

curve fotometriche disponibili photometrics available

RING



Lampada da parete e soffitto. Wall and ceiling lamp.

**Struttura in metallo cromato
o ottonato o verniciato.
Diffusore in vetro serigrafato.**

Trim available in chrome,
brass and white painted.
Screen-printed glass diffuser.

Structure métallique vernie
ou galvanisée. Verre satiné
sérigraphié.

Struktur aus lackiertem oder
galvanisiertem Metall.
Glas seidenmatt mit Siebdruck.

Estructura metálica
lacada o galvanizada.
Vidrio satinado serigrafiado.

Кольцо хромового, латунного
или белого цвета. Рассеиватель из
стекла. Трафаретная печать.



**Ring-5 disponibile nella
versione in emergenza.**
Ring-5 available with emergency kit.

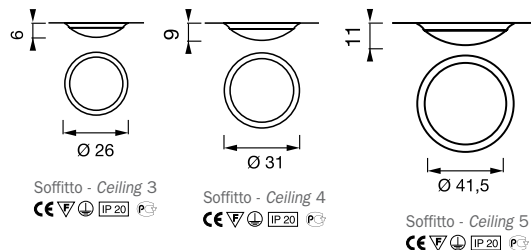

	ELECTR.	SOCKET	LAMP	CODE	FINISHING
SOFFITTO CEILING 3	1x42W	E27	A55	P101	16 - 22 - 23
SOFFITTO CEILING 4	1x17W	dimmerable LED	3.000°K	P282	16 - 22 - 23
SOFFITTO CEILING 4	2x28W	E27	A55	P102	16 - 22 - 23
SOFFITTO CEILING 4	1x28W	GR10q	TC-DDE	P103	16 - 22 - 23
SOFFITTO CEILING 4	2x18W	G24d-2	TC-D	P222	16 - 22 - 23
SOFFITTO CEILING 5	2x42W	E27	A55	P257	16 - 22 - 23
SOFFITTO CEILING 5	22+40W	2GX13 electronic ballast	T5c	P258	16 - 22 - 23
SOFFITTO CEILING 5	1x38W	GR10q electronic ballast	TC-DDE	P259	16 - 22 - 23
SOFFITTO CEILING 5	2x26W	G24q-3 electronic ballast	TC-DE	P260	16 - 22 - 23

Finiture
Finishings

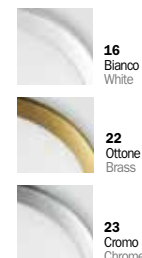

KOMET



Lampada da soffitto. Ceiling lamp. / Lampada da parete. Wall lamp.

**Struttura metallica verniciata.
Diffusore in vetro satinato.**

Satin glass diffuser.
Chrome glass holders.

Structure métallique vernie.
Verre satiné.

Struktur aus lackiertem Metall.
Glas seidenmatt.

Estructura metálica lacada.
Vidrio satinado.

Рассеиватель из матового стекла
Хромовые держатели.

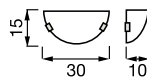

Parete - Wall A

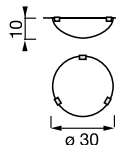

Soffitto - Ceiling P3

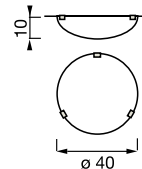

Soffitto - Ceiling P4



	ELECTR.	SOCKET	LAMP	CODE	FINISHING
PARETE WALL A	1x42W	E27	A55	P034	23
SOFFITTO CEILING P3	1x17W	dimmerable LED	3.000°K	P281	23
SOFFITTO CEILING P3	1x42W	E27	A55	P035	23
SOFFITTO CEILING P4	2x42W	E27	A55	P002	23

HOOK



Lampada da soffitto. Ceiling lamp. / Lampada da parete. Wall lamp.

Reggivetiro in metallo cromato o ottonato.
Diffusore in vetro satinato.

Glass holders available in chrome and brass Satin glass diffuser.

Support laqué, diffuseur en verre satiné.

Lackierte Armatur verchromt oder mit Messingbeschichtung Fluter aus Glas seidenmatt.

Soporte del vidrio de metal cromado o bronceado. Vidrio satinado.

Хромовые или латунные держатели
Рассеиватель из матового стекла.

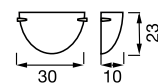

Parete - Wall A

CE

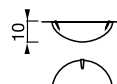

Soffitto - Ceiling P3

CE

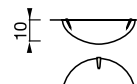

Soffitto - Ceiling P4

CE

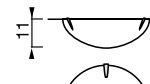

Soffitto - Ceiling P5

CE

	ELECTR.	SOCKET	LAMP	CODE	FINISHING
PARETE WALL A	1x42W	E27	A55	P017	22 - 23
SOFFITTO CEILING P3	1x17W	dimmerable LED	3.000°K	P280	22 - 23
SOFFITTO CEILING P3	1x52W	E27	A55	P018	22 - 23
SOFFITTO CEILING P3	1x22W	G10q	T-R	P231	22 - 23
SOFFITTO CEILING P4	2x42W	E27	A55	P019	22 - 23
SOFFITTO CEILING P4	1x32W	G10q	T-R	P232	22 - 23
SOFFITTO CEILING P4	2x18W	G24q-2	emergency 1h TC-DE	P249	22 - 23
SOFFITTO CEILING P5	3x42W	E27	A55	P265	22 - 23
SOFFITTO CEILING P5	2x26W	G24q-3	electronic ballast TC-DE	P266	22 - 23
SOFFITTO CEILING P5	22+40W	2GX13	electronic ballast T5c	P267	22 - 23
SOFFITTO CEILING P5	1x38W	GR10q	electronic ballast TC-DDE	P268	22 - 23

Finiture
Finishings



22
Ottone
Brass



23
Cromo
Chrome

POCKET



Lampada da soffitto. Ceiling lamp. / Lampada da parete. Wall lamp.

Reggivetri in metallo cromato o ottonato.
Diffusore in vetro satinato.

Glass holders available in chrome and brass. Satin glass diffuser.

Support laqué, diffuseur en verre satiné.

Lackierte Armatur verchromt oder mit Messingbeschichtung. Fluter aus Glas seidenmatt.

Soporte del vidrio de metal cromado o bronceado. Vidrio satinado.

Хромовые или латунные держатели. Рассеиватель из матового стекла.

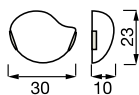

Parete - Wall A
CE V A IP 20 P3

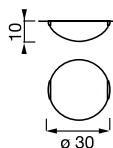

Soffitto - Ceiling P3
CE V A IP 20 P3

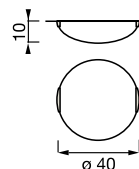

Soffitto - Ceiling P4
CE V A IP 20 P3

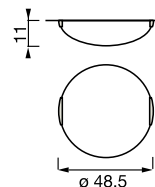

Soffitto - Ceiling P5
CE V A IP 20 P3

	ELECTR.	SOCKET	LAMP	CODE	FINISHING
PARETE WALL A	1x42W	E27	A55	P014	22 - 23
SOFFITTO CEILING P3	1x17W	dimmerable LED	3.000°K	T358	22 - 23
SOFFITTO CEILING P3	1x52W	E27	A55	P015	22 - 23
SOFFITTO CEILING P3	1x22W	G10q	T-R	P229	22 - 23
SOFFITTO CEILING P4	2x42W	E27	A55	P016	22 - 23
SOFFITTO CEILING P4	1x32W	G10q	T-R	P230	22 - 23
SOFFITTO CEILING P4	2x18W	G24q-2 emergency 1h	TC-DE	P248	22 - 23
SOFFITTO CEILING P5	3x42W	E27	A55	P269	22 - 23
SOFFITTO CEILING P5	2x26W	G24q-3 electronic ballast	TC-DE	P270	22 - 23
SOFFITTO CEILING P5	22+40W	2GX13 electronic ballast	T5c	P271	22 - 23
SOFFITTO CEILING P5	1x38W	GR10q electronic ballast	TC-DDE	P272	22 - 23

Finiture
Finishings



22
Ottone
Brass



23
Cromo
Chrome

BRAKET

Lampada da parete. Wall lamp.

Reggivetri cromati e diffusore in vetro colorato satinato.

Metal back plate. Satin glass diffuser.
Chromed glass holder.

Supports chromée,
diffuseur en verre satiné.

Armatur aus Metall, satiniertem Glass.

Soportes del vidrio cromado
y vidrio colorado satinado.

Рассеиватель из матового стекла.

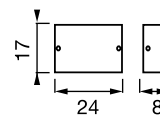

Parete - Wall



Varianti vetro
Glass colour options



16
Bianco
White



01
Ambr
Amber

	ELECTR.	SOCKET	LAMP	CODE	FINISHING
PARETE WALL	1x28W	E14	P45 	P032	01 - 16

MOON

Lampada da parete e soffitto. Wall and ceiling lamp.

Struttura in metallo verniciato.
Diffusore in vetro satinato.

Painted metal frame.
Satin glass diffuser.

Structure en métal laqué,
diffuseur en verre satiné.

Armaturo aus lackiertem Metall,
Glas seidenmatt.

Estructura de metal barnizado.
Vidrio satinado.

Окрашенный металл
Рассеиватель из матового стекла.

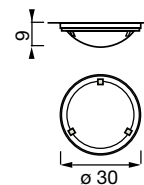

Soffitto - Ceiling MOON

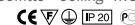

Finiture
Finishings



16
Bianco
White





































28
Grigio-argento
Silver grey

	ELECTR.	SOCKET	LAMP	CODE	FINISHING
SOFFITTO CEILING MOON	1x42W	E27	A55 	P008	16 - 28

LAMPADINE - BULBS - AMPOULES - LAMPEN - BOMBILLAS















Lampadine fluorescenti

Fluorescent lamps

Symbol	Uni	Wattage	Socket	Code
	TC-S	9W	G23	052564
	TC-SE	11W	2G7	052559
	TC-D	13W	G24d-1	052560
	TC-D	18W	G24d-2	052569
	TC-D	26W	G24d-3	052562
	TC-DE	18W	G24q-2	052563
	TC-DE	26W	G24q-3	052565
	TC-DD	16W	GR8	052561
	TC-DD	28W	GR8	052566
	TC-DDE	10W	GR10q	052570
	TC-DDE	28W	GR10q	052567
	TC-DDE	38W	GR10q	052568
	TC-L	18W	2G11	052622
	TC-L	24W	2G11	052621
	TC-L	36W	2G11	052624
	TC-L	55W	2G11	052650
	TC-F	24W	2G10	052604
	TC-F	36W	2G10	052608
	TC-TSE	14W	E27	052630
	TC-TSE	17W	E27	052528
	TC-TSE	21W	E27	052648
	TC-TSE	24W	E27	052638
	TC-TSE	30W	E27	052668
	T16 (T5)	24W	G5	052625
	T16 (T5)	28W	G5	052667
	T16 (T5)	39W	G5	052623
	T16 (T5)	54W	G5	052649
	T5c	22W	2GX13	052639
	T5c	40W	2GX13	052641
	T5c	55W	2GX13	052640
	T-R	22W	G10q	052642
	T-R	32W	G10q	052644
	MICROLYNX_F	7W	GX53	052647
	MICROLYNX_F	9W	GX53	052662





Lampadine alogene

Halogen lamps

Symbol	Uni	Wattage	Socket	Code
	QT-13	20W	G9	052532
	QT-13	33W	G9	052535
	QT-13	48W	G9	052540
	QT-14	60W	G9	052531
	QT-DE 78mm	80W	R7s	052533
	QT-DE 78mm	120W	R7s	052534
	QT-DE 118mm	120W	R7s	052536
	QT-DE 118mm	160W	R7s	052521
	QT-DE 118mm	230W	R7s	052522
	QPAR	50W	GU10	052530
	QPAR	75W	GU10	052527
	QT-32	70W	E27	052636
	QT-32	100W	E27	052637
	QT-32	205W	E27	052663

Lampadine ad incandescenza -

incandescent lamps

Symbol	Uni	Wattage	Socket	Code
	A55	28W	E27	052665
	A55	42W	E27	052611
	A55	52W	E27	052612
	A55	70W	E27	052602
	A55	105W	E27	052666
	B35	28W	E14	052664
	P45	28W	E14	052609
	P45	42W	E14	052613

Tutti i prodotti di GRUPPO ROSTIROLLA s.r.l. che rientrano nell'ambito di applicazione della direttiva europea EMC 89/336 e 93/68 EEC, soddisfano i requisiti richiesti e recano la marcatura **CE**. Il simbolo **CE** è posto sull'imballo del prodotto.

Nella continua ricerca di miglioramenti tecnici e funzionali, GRUPPO ROSTIROLLA s.r.l. si riserva il diritto di apportare modifiche anche sostanziali ai propri prodotti, che potranno essere effettuate senza preavviso. Disegni, quote e colori sono da intendersi a titolo puramente indicativo e non sono impegnative per GRUPPO ROSTIROLLA s.r.l.

All the products of GRUPPO ROSTIROLLA s.r.l. meet with current European directives EMEC 89/336 and 93/68 EEC, meet their requirements and are **CE** marked. The symbol **CE** is placed on the packaging of the product.

In accordance with its policy of continuous products development GRUPPO ROSTIROLLA s.r.l. reserves the right to modify its products without prior notice. Descriptions, charges and colours in this catalogue are indicative.

Degree of ingress protection

IP20: Protezione contro l'ingresso di corpi solidi $\varnothing \geq 12\text{mm}$
Protected against the penetration of solid bodies $\varnothing \geq 12\text{mm}$

IP30: Protezione contro l'ingresso di corpi solidi $\varnothing \geq 2,5\text{ mm}$
Protected against the penetration of solid bodies $\varnothing \geq 2,5\text{mm}$

IP40: Protezione contro l'ingresso di corpi solidi $\varnothing \geq 1\text{mm}$
Protected against the penetration of solid bodies $\varnothing \geq 1\text{mm}$

IP44: Protezione contro l'ingresso di corpi solidi $\varnothing \geq 1\text{mm}$
e contro gli spruzzi
Protected against the penetration of solid bodies $\varnothing \geq 1\text{mm}$
and against the squeezes

IP54: Protezione contro l'ingresso della polvere e contro gli spruzzi d'acqua
Protected against the penetration of dust and water splash

Approvals



Certificazione di conformità europea
Certification of European conformity



Apparecchio idoneo al montaggio su superfici infiammabili
Luminaire suitable for installation on inflammable surfaces



GOST
Certificazione di conformità valida per la Federazione Russa
Certification for Russian Federation

Class



Classe I - Class I - Classe I - Klasse I - Classe I

Apparecchio nel quale la sicurezza elettrica è garantita da un conduttore supplementare di protezione (messa a terra) collegato alla struttura metallica della lampada.

A light fitting whose safety is guaranteed by an additional protective conductor (earth) connected with the metal frame of the lamp.



Classe II - Class II - Classe II - Klasse II - Classe II

Apparecchio nel quale la protezione contro la scossa elettrica si basa unicamente sul doppio isolamento e/o isolamento rinforzato in ogni parte e senza dispositivo di messa a terra.

Light fittings whose safety is guaranteed by the double reinforced insulation of conductive parts, with no earth.

Direttiva RAEE: Rifiuti di Apparecchiature Elettriche ed Elettroniche

Il 25 Luglio 2005 il Consiglio dei Ministri ha recepito con Decreto Legislativo no 151 la Direttiva Europea 2002/95/CE e 2002/96/CE relativa alla riduzione delle sostanze pericolose nelle apparecchiature elettriche ed elettroniche e dello smaltimento dei rifiuti da essi derivanti. L'obiettivo è promuovere una logica di sviluppo sostenibile nel settore delle apparecchiature elettriche ed elettroniche, di cui gli apparecchi di illuminazione ne fanno parte, ai fini di un corretto trattamento dei prodotti a fine vita e ciò può attuarsi attraverso la piena conformità alla Direttiva RAEE. Il Produttore, come definito dal Dlgs no 151, dovrà farsi carico dei costi di gestione che comprendono la raccolta, presso gli impianti di stoccaggio provvisorio e dello smaltimento dei rifiuti degli apparecchi di illuminazione immessi sul mercato dopo l'Agosto 2006. Per adempiere a questi obblighi di legge LUCENTE S.r.l. ha deciso di avvalersi del supporto del Consorzio ECOLIGHT, Via Gattamelata 34, 20149 Milano Tel 02 33600732.



Gli apparecchi di illuminazione saranno marcati in modo da identificare il Produttore e riportare il simbolo del cassonetto barrato, indicante la raccolta differenziata separata dal resto dei rifiuti urbani, inoltre saranno soggetti al contributo di smaltimento, differenziato per fascia di peso. Gli utenti finali potranno consegnare i suddetti apparecchi senza costi aggiuntivi presso i punti di raccolta appositamente realizzati e comunicati dal Consorzio. I distributori sono obbligati ad assicurare al momento della fornitura di una nuova apparecchiatura, il ritiro gratuito, in ragione di uno ad uno, della apparecchiatura usata. L'obbligo di informazione relativo al contributo dovrà essere mantenuto visibile in fattura, da parte del Produttore, fino al 13 febbraio 2011.

I prodotti elencati con il relativo peso netto alla fine del presente catalogo saranno soggetti al contributo di smaltimento a seconda della fascia di peso di appartenenza:

- fascia 1: apparecchi il cui peso è compreso tra 0 e 2 Kg
- fascia 2: apparecchi il cui peso è compreso tra 2 e 8 Kg
- fascia 3: apparecchi il cui peso è superiore a 8 Kg

Direttiva RoHS

Il Decreto Legislativo sopra menzionato incorpora anche la Direttiva 2002/95/CE - RoHS - Limiti d'uso di alcune sostanze pericolose - relativa alla riduzione delle sostanze pericolose nelle apparecchiature elettriche ed elettroniche.

A partire dal 1° Luglio 2006 tutte le nuove apparecchiature elettriche ed elettroniche immesse sul mercato non dovranno contenere o contenere in misura limitata sostanze quali: Piombo, Mercurio, Cadmio, Cromo esavalente, Bifenile polibromurati (PBB), Eteri difendi polibromurati (PBDE).

WEEE Directive: Waste Electrical and Electronic Equipment

On the 25th July 2005, the Council of Ministers incorporated the European Directive 2002/95/CE and 2002/96/CE – related to the reduction of hazardous substances in electronic and electrical equipment and their waste disposal - into Italian legislation with the Legislative Decree number 151. The objective is that of promoting a notion of sustainable development within the electronic and electrical equipment sector, to which lighting equipment belongs, with the aim of correctly treating the products once they have reached the end of their lives; this may be accomplished by fully complying with the WEEE Directive. The Manufacturer, as defined by the Legislative Decree number 151, will be responsible for the management costs which include collection from temporary storage facilities and the costs for waste disposal of the lighting Equipment. In order to fulfil these legal obligations LUCENTE S.r.l. have decided to call upon the support of the ECOLIGHT Consortium; Consorzio ECOLIGHT, Via Gattamelata 34, 20149 Milan Tel. +39 02 3360 0732.



The lighting equipment will be marked in such a way as to identify the Manufacturer and show the symbol of the crossed wheeled bin, which indicates a separate collection from the rest of the urban waste, the equipment will also be subject to a disposal contribution and will be distinguishable by its weight range. The contribution will be determined prior to the law coming into force and will be made official by the ECOLIGHT Consortium. The end users will be able to deliver the above-mentioned equipment without any add-on costs to the authorised collection sites as notified by the Consortium. Distributors are obliged to ensure a free take-back service of the used equipment, at the time of the supply of a new unit, on a one-to-one basis. The Manufacturer has a duty to supply and maintain information related to the amount of contribution and this must be shown on invoices until 13th February 2011.

The products listed in this catalogue will be marked with range symbols. Each symbol should be shown against its relevant range within the following table and each range will be subject to a different disposal contribution:

- range 1: the equipment weight which is between 0 and 2 kg
- range 2: the equipment weight which is between 2 up to 8 kg
- range 3: the equipment weight which is over 8 kg

The RoHS Directive

The above-mentioned Legislative Decree has also implemented the RoHS 2002/95/CE Directive. The Restriction of the use of certain Hazardous Substances (RoHS) in electrical and electronic equipment.

As from 1st July 2006, all new electrical and electronic equipment put on the market must not contain, or contain limited quantities of, certain substance, namely: Lead, Mercury, Cadmium, Hexavalent chromium, Polybromide biphenyls (PBBs), Polybromide diphenyl ethers (PBDEs).

Edizione giugno 2013

Concept and graphic design: Anna Silvestrini

Print:



LUCENTE®

is a brand of
GRUPPO ROSTIROLLA Srl

Via Piemonte 1/A
31038 Padernello di Paese
Treviso - Italy

Tel. +39 0422 4575
Fax +39 0422 950720

info@lucente.eu
www.lucente.eu