



**DESIGN**  
COLLECTION  
2013

**LUCENTE®**

DESIGN

---

COLLECTION

2013

LUCENTE®



ALESSANDRO  
MENDINI



DODO  
ARSLAN



PAOLO  
DE LUCCHI



R&S  
CORNELISSEN



CARLO  
FORCOLINI



NORWAY  
SAYS



MARTEN CLAESSON,  
EERO KOIVISTO,  
OLA RUNE



MARIO  
MAZZER

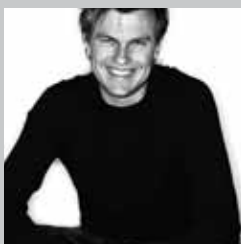

THOMAS  
SANDELL



ROBERTO  
FAVARETTO



SIMONE  
DERAI



GIANDOMENICO  
BELOTTI

# DESIGNERS

---



SANDRO  
SANTANTONIO



BRIAN  
RASMUSSEN



CAMBI,  
SCATENA,  
TURINI



# INDEX

---

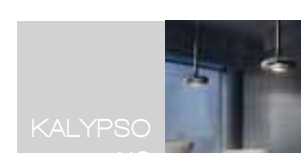
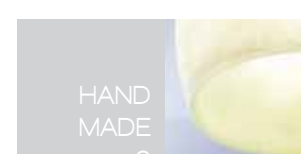
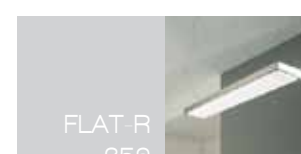
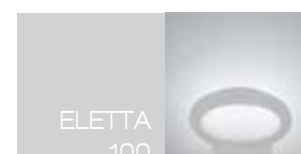
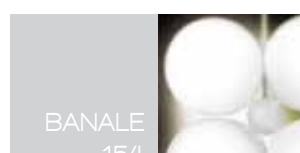
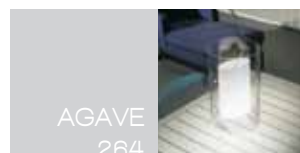
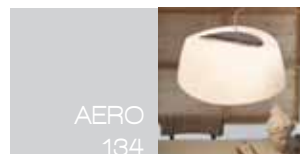

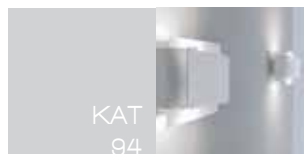

KAT  
94

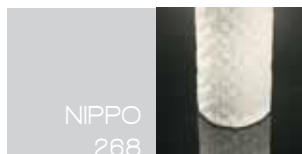

NIPPO  
268

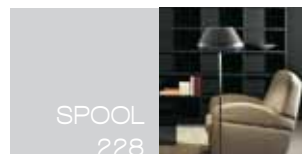

SPOOL  
228



LANCIA  
114



NOA  
174

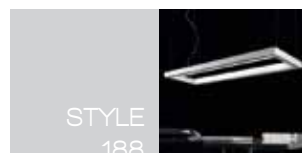

STYLE  
188

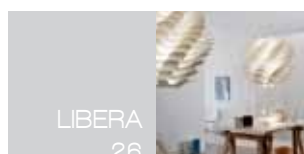

LIBERA  
26

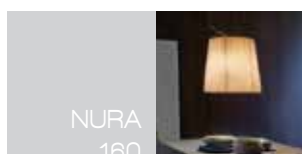

NURA  
160

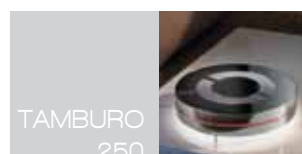

TAMBURO  
250

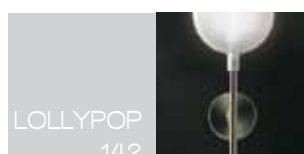

LOLLYPOP  
142



PINKO  
216

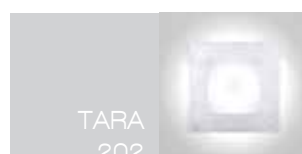

TARA  
202



MAI  
64

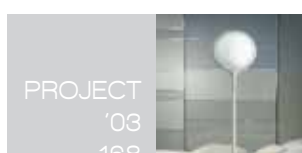

PROJECT  
'03  
168



UP  
70

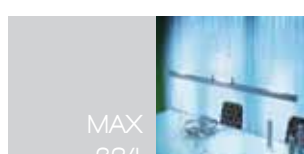

MAX  
234



REMEMBER  
222



VERSO  
96

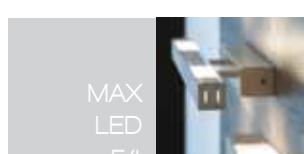

MAX  
LED  
54

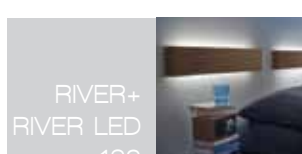

RIVER+  
RIVER LED  
196



VITA  
58



MAX-H  
244



SAO  
206

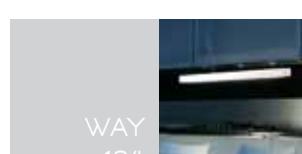

WAY  
184



MINI  
LIBERA  
32



SEMJASE  
80



WEDGE  
118

# HAND MADE IP44

design Sandro Santantonio Design 2013

**Lampade in fibra di vetro naturale totalmente lavorate a mano, adatte anche all'esterno. Grado di protezione IP44.**

Individually handmade and crafted lamps in natural fiberglass also suitable for outdoor application. IP44.

Lampes en fibre de verre de couleur naturel, entièrement faites à la main. Egalement appropriés pour l'extérieur. IP44.

Leuchten aus Natur Fiberglas komplett Hand Made, geeignet auch für Außen. IP 44.

Lámparas en fibra de vidrio natural hechas totalmente a mano. Grado de protección IP44.

Сделанный вручную светильник из стекловолокна, который можно использовать не только внутри, но и снаружи. Степень защиты IP44.

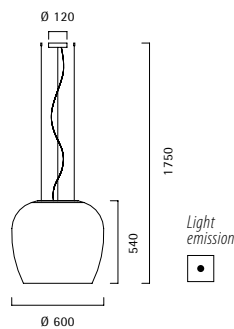

**Versione da esterno IP44**  
Outdoor IP44

Sospensione - *Pendant lamp*

**012130** Vetoresina naturale - *Natural fiberglass*

E27 3x30W TC-TSE

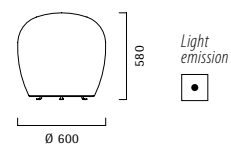

**Versione da esterno IP44**  
Outdoor IP44

Lampada da terra - *Floor lamp*

**012135** Vetoresina naturale - *Natural fiberglass*

E27 3x20W TC-TSE



HAND MADE IP44  
design Sandro Santantonio Design 2013



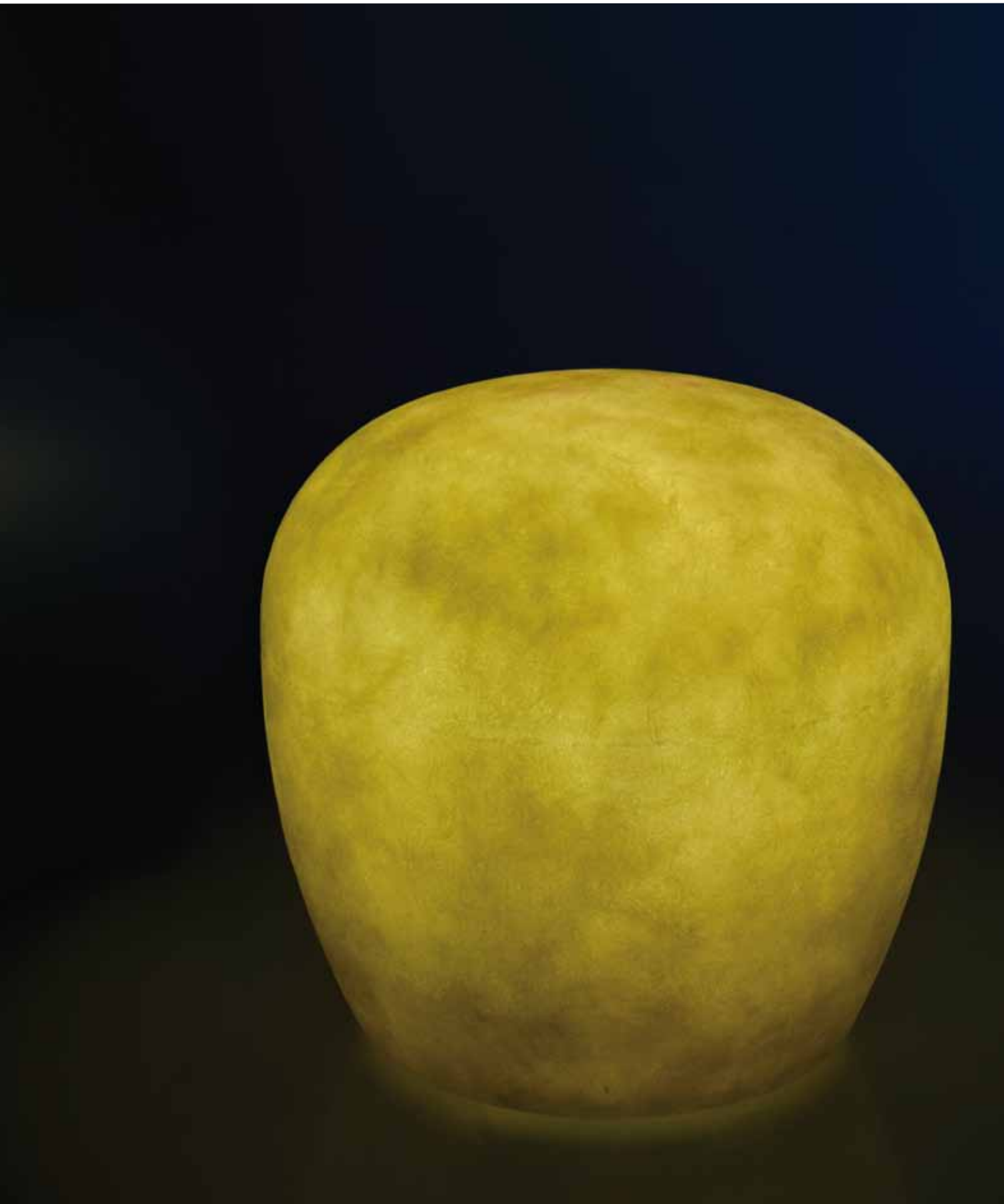





HAND MADE IP44  
design Sandro Santantonio Design 2013





# HAND MADE

design Sandro Santantonio Design 2013





**Lampade a sospensione in fibra di vetro dipinta a mano. Disponibile nella finitura nera lucida e opaca, bianca lucida e opaca. Interni foglia oro o foglia argento.**

Individually handmade and painted pendant lamps in fiberglass. Finishes are lacquer or matt black outside / gold leaf inside and lacquer or matt white outside / silver leaf inside.

Suspension en fibre de verre, peints à la main. Existent en finitions suivantes : Extérieure : Noir Mat, Noir Brillant, Blanc brillant et Blanc Mat Intérieure : Feuille d'or ou Feuille argent

Pendelleuchten aus Fiberglas, innen und außen handgestrichen. Erhältlich in den Ausführungen Schwarz oder Weiß poliert oder matt. Innen Blattgold oder Blattsilber.

Lámparas colgantes en fibra de vidrio pintada a mano. Disponible en negro mate y brillante, blanco brillante y mate. Interior en lámina oro o lámina de plata.

Подвесной светильник из стекловолокна, раскрашенный вручную. Внешняя отделка может быть: черная матовая и блестящая, белая матовая и блестящая. Внутренняя часть может быть отделана сусальным золотом или серебром.

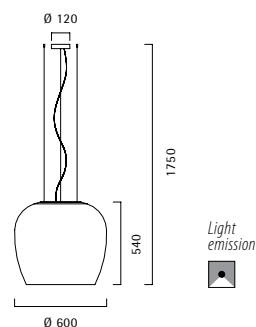

**Versione da interno IP20**

Indoor IP20

Sospensione - Pendant lamp

**012131** Nero opaco/oro - Matt black/gold

**012132** Nero lucido/oro - Glossy black/gold

**012133** Bianco opaco/argento - Matt white/silver

**012134** Bianco lucido/argento - Glossy white/silver

E27 3x30W TC-TSE

CE IP20

# HAND MADE

design Sandro Santantonio Design 2013





# HAND MADE

design Sandro Santantonio Design 2013









# HAND MADE

design Sandro Santantonio Design 2013





**Lampade a sospensione e soffitto con struttura metallica e rivestimento in tessuto elasticizzato sfoderabile e lavabile. Tessuto disponibile nei colori avorio oppure rosso.**

Pendant and ceiling lamps. Metal structure and removable and washable stretch-fabric in ivory and red.

Suspension et plafond avec structure en métal et tissu élastique amovible. Tissu lavable. Existent en finition ivoire et Rouge.

Pendel und Deckenleuchten. Struktur aus Metall überzogen mit einem elastischen Stoff, abnehmbar und waschbar. Stoff erhältlich in Elfenbein und Rot.

Lámparas colgantes y de techo con estructura de metal y revestimiento de tejido elástico extraíble y lavable. Tejido disponible en marfil o rojo.

Подвесной и потолочный светильник со структурой из металла, на которую натягивается эластичная моющаяся ткань. Цвет ткани может быть красный или светло-бежевый.

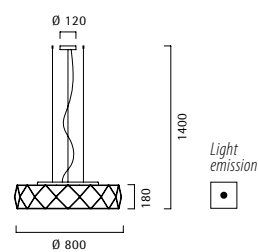

Lampada sospensione - *Pendant lamp*

**012270** Avorio - *Ivory*

**012271** Rosso - *Red*

E27 4x30W TC-TSE

CE

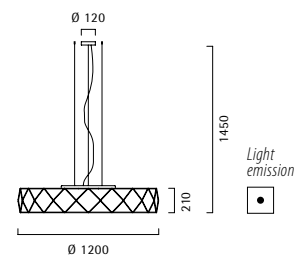

Lampada sospensione - *Pendant lamp*

**012274** Avorio - *Ivory*

**012275** Rosso - *Red*

E27 5x30W TC-TSE

CE

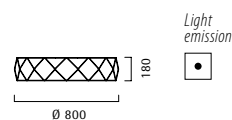

Lampada da soffitto - *Ceiling lamp*

**012272** Avorio - *Ivory*

**012273** Rosso - *Red*

E27 4x30W TC-TSE

CE

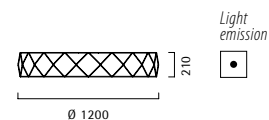

Lampada da soffitto - *Ceiling lamp*

**012276** Avorio - *Ivory*

**012277** Rosso - *Red*

E27 5x30W TC-TSE

CE





GRESY

design Cambi, Scatena, Turini 2013





GRESY

design Cambi, Scatena, Turini 2013





# LIBERA

design Brian Rasmussen 2012

**Scenografica lampada realizzata con fogli in alluminio di diverse misure sovrapposti che rendono la forma dinamica, come un'onda in movimento. Al centro un cilindro luminoso in vetro soffiato si riflette sugli elementi, creando un suggestivo gioco di luci ed ombre sempre diverso, a seconda delle angolazioni. Disponibile in colore verniciato bianco opaco.**

A suspended pendant consisting of differing sizes of formed aluminium sheets. These are placed one over the other giving the fitting a dynamic look similar to a wave's. The lamp is located inside the blown glass cylinder in the centre. The light reflection makes a suggestive play of light and shadow according to the perspective. Matt white painted pendant and table lamps.

Lampe pittoresque réalisée avec des feuilles d'aluminium de différentes mesures superposées de manière scalaire autour d'un cylindre lumineux en verre soufflé, qui reflète la lumière sur les éléments. Le jeu d'ombres et de lumières, qui varie toujours en fonction des angles, rend la forme dynamique et suggère un mouvement d'ondes. Cette lampe est disponible peinte en couleur blanc opaque, et dans les versions à suspension et de table.

Wirkungsvolle Lampe aus Aluminiumblättern unterschiedlicher Größe. Sie sind nach ihrer Größe um einen leuchtenden Zylinder aus geblasenem Glas angeordnet, der das Licht auf die Elemente zurückwirft. Ein je nach Winkel sich ständig wandelndes Spiel aus Schatten und Licht gibt der Form eine gewisse Dynamik und lässt eine Wellenbewegung entstehen. Die Lampe ist in den Farben Mattweiß, als Hänge- und als Tischlampe lieferbar.

Espectacular lámpara realizada con hojas de aluminio de diversos tamaños, superpuestas de modo que se escalonan en torno a un cilindro luminoso realizado en cristal soplado, que refleja la luz sobre los elementos que la conforman. El juego de luces y sombras, siempre diverso dependiendo de los diferentes ángulos, hace que su forma resulte dinámica y sugiere un movimiento ondoso. La lámpara se encuentra disponible pintada en color blanco mate, tanto en su versión de colgar como de mesa.

Живописный светильник, изготовленный из алюминиевых листов различных размеров, наложенных друг на друга вокруг светящегося цилиндра из дутого стекла, который отражает свет на элементы. Игра света и тени, всегда различная в зависимости от угла зрения, создает динамичную форму и волнообразное движение. Светильник матового белого цвета предлагается в подвесном или настольном варианте.



Lampada da tavolo - Table lamp

**013022** Bianco opaco - Matt white

E27 2x100W QT-32

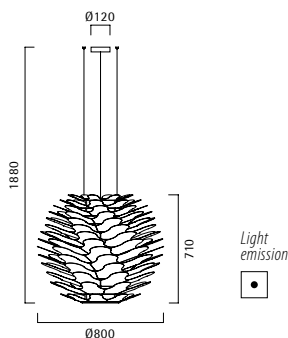

Lampada sospensione - Pendant lamp

**013021** Bianco opaco - Matt white

E27 3x100W QT-32 + E27 PAR38 1x100W or Led 15W

E27 4x100W QT-32

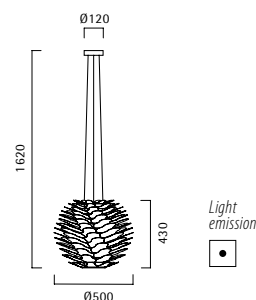
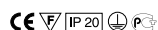

Lampada sospensione - Pendant lamp

**013020** Bianco opaco - Matt white

E27 2x100W QT-32

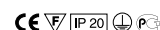







# LIBERA

design Brian Rasmussen 2012









# MINI LIBERA

design Brian Rasmussen 2013





**Nuova versione, di piccole dimensioni della lampada Libera che nella versione "Mini" offre versatilità di collocazione ed è disponibile in versione alogena e a LED.**

A small version of the LIBERA range. The MINI LIBERA is a versatile lamp for several project applications. LED and halogen versions available.

Nouvelle version, taille réduite de la lampe Libera. La version «Mini» offre une bonne polyvalence d'installation et est disponible dans les versions halogène et à LED.

Eine neue Ausführung, mit einem kleinen Durchmesser der Leuchte LIBERA. Die „Mini“ Ausführung bietet vielfältige Einsatzmöglichkeiten und ist in Halogen und LED Version erhältlich.

Nueva versión, de dimensiones reducidas, de la lámpara Libera. La versión "Mini" resulta muy versátil, en lo que se refiere a su colocación, y se encuentra disponible en versión halógena o con leds.

Новая версия небольших размеров светильника Libera представлена по дизайну Брайана Расмуссена. Версия "Mini" предлагает множество вариаций размещения, изделия которой выполнены в галогенной и светодиодной разновидностях .

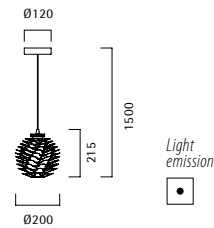

Lampada sospensione - *Pendant lamp*  
Bianco opaco - *Matt white*

**013015** LED 1x8,4W 3.000°K

**013016** G9 2x20W QT-13

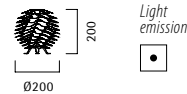
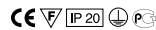

Lampada da tavolo - *Table lamp*  
Bianco opaco - *Matt white*

**013018** LED 1x8,4W 3.000°K

**013017** G9 2x20W QT-13



# MINI LIBERA

design Brian Rasmussen 2013









# MINI LIBERA

design Brian Rasmussen 2013



Serie di lampade con struttura in alluminio nella forma a tronco di cono. La parte superiore del paralume presenta delle fessure a raggiera che danno particolarità e carattere al design semplice e lineare dell'oggetto. Disponibile in due colori: interamente verniciata bianca opaco oppure nero opaco all'esterno e bianca opaco all'interno. Illuminazione a LED. Diffusore prismatico trasparente all'interno. Alimentatore incluso.

Tapered Cone-shaped aluminium LED lamps. The top of the lamp has some simple detail cut-outs, enhancing the linear design of the lamp with a smart, distinctive touch. Finishes are matt white painted inside/outside and matt black outside/matt white inside. Transparent prismatic diffuser within the base of the lamp. Ballast included.

Série de lampes avec une structure en aluminium, caractérisées par leur forme en tronc de cône. La partie supérieure de l'abat-jour présente des fentes en configuration radiale, qui permettent l'aération et donnent en même temps un caractère particulier au design simple et linéaire de cet objet. Disponible en deux couleurs: entièrement peinte en blanc opaque, ou bien noir opaque à l'extérieur et blanc opaque à l'intérieur. Eclairage à LED. Diffuseur prismatique transparent à l'intérieur. Alimentation incluse.

Amak ist eine Lampen-Modellpalette mit einer Aluminiumstruktur, die durch ihren keilförmigen Ständer besticht. Der obere Teil des Schirms ist mit strahlenförmigen Schlitzen für eine effiziente Kühlung versehen mit gleichzeitig der stilistischen Aufgaben, ein einfaches und geradliniges Design entstehen zu lassen. Sie ist mit zwei Farben erhältlich: matt weiß lackiert oder Außen mattschwarz und Innen matt weiß. LED Leuchten. Innen durchsichtiger prismatischer Lichtverteiler. Der Konverter ist inklusive.

Serie de lámparas con estructura de aluminio con forma de cono truncado. La parte superior de la pantalla incluye unas fisuras radiales que permiten su aireación y, al mismo tiempo, le dan singularidad y carácter al diseño simple y lineal del artículo. Se encuentra disponible en dos colores: totalmente pintada de blanco mate o, también, negro mate en su exterior y blanco mate en su interior. Iluminación con LED. Difusor en forma de prisma transparente en su interior. Alimentador incluido.

Amak представляет собой серию светильников с алюминиевой структурой, характеризующейся формой усеченного конуса. Светильник может быть выполнен в двух цветовых вариантах: полностью окрашенный в матовый белый или матовый черный снаружи и матовый белый внутри. Используются светодиодные лампы, тональности, внутри установлен прозрачный призматический диффузор. Имеется встроенный электронный балласт.

curve fotometriche disponibili photometrics available 

**Bianco/bianco**  
White/white



**Nero/bianco**  
Black/white



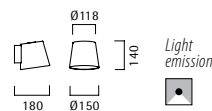

Lampada da parete - Wall lamp

**014416** Bianco/bianco - White/white

**014417** Nero/bianco - Black/white

LED 8,4W 3.000°K

**014418** Bianco/bianco - White/white

**014419** Nero/bianco - Black/white

LED 8,4W 4.100°K

CE

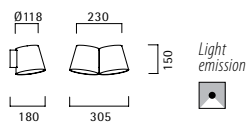

Lampada da parete - Wall lamp

**014420** Bianco/bianco - White/white

**014421** Nero/bianco - Black/white

LED 2x8,4W 3.000°K

**014422** Bianco/bianco - White/white

**014423** Nero/bianco - Black/white

LED 2x8,4W 4.100°K

CE

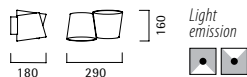

Lampada da parete - Wall lamp

**014424** Bianco/bianco - White/white

**014425** Nero/bianco - Black/white

LED 2x8,4W 3.000°K

**014426** Bianco/bianco - White/white

**014427** Nero/bianco - Black/white

LED 2x8,4W 4.100°K

CE

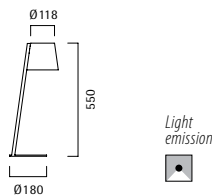

Lampada da tavolo - Table lamp

**014429** Bianco/bianco - White/white

**014430** Nero/bianco - Black/white

LED 8,4W 3.000°K

CE

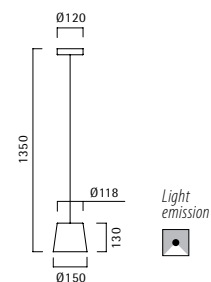

Lampada sospensione - Pendant lamp

**014404** Bianco/bianco - White/white

**014405** Nero/bianco - Black/white

LED 8,4W 3.000°K

**014406** Bianco/bianco - White/white

**014407** Nero/bianco - Black/white

LED 8,4W 4.100°K

CE

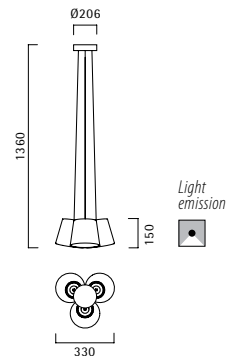

Lampada sospensione - Pendant lamp

**014408** Bianco/bianco - White/white

**014409** Nero/bianco - Black/white

LED 3x8,4W 3.000°K

**014410** Bianco/bianco - White/white

**014411** Nero/bianco - Black/white

LED 3x8,4W 4.100°K

CE

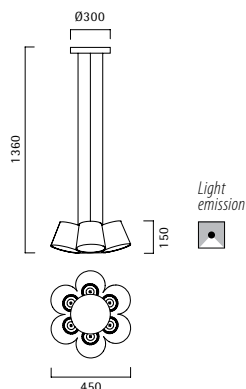

Lampada sospensione - Pendant lamp

**014412** Bianco/bianco - White/white

**014413** Nero/bianco - Black/white

LED 7x8,4W 3.000°K

**014414** Bianco/bianco - White/white

**014415** Nero/bianco - Black/white

LED 7x8,4W 4.100°K

CE











AMAK

design R&S Cornelissen 2012



# AMAK

design R&S Cornelissen 2012







AMAK

design R&S Cornelissen 2012



AMAK

design R&S Cornelissen 2012















Atlante della moda

SED

11 12 1  
10 VERSA 2  
9 3  
8 4  
7 6 5

SECABA  
39

AMAK

design R&S Cornelissen 2013



# MAX LED

design Lucente Lab

**Lampade a led in estruso di alluminio verniciato bianco. Vetro di protezione in pirex satinato.**

LED lamps in white painted extruded aluminium. Satin pyrex protection glass.

Applique et suspension en LED.  
Structure en extrudé d'aluminium laqué blanc. Verre de protection en pyrex satiné.

Applique et suspension en LED.  
Structure en extrudé d'aluminium verni blanc. Verre de protection en pyrex satiné.

LED Leuchten aus extrudiertem Aluminium weiß lackiert. Schutzglas aus satiniertem Pyrex.

Lámpara colgante y de pared.  
Iluminación LED. Estructura en extruido de aluminio barnizado en blanco.  
Vidrio de protección en pirex satinado.

Светильник со светодиодами. Корпус выполнен из экструдированного алюминия, окрашен в белый цвет.  
Защитный экран изготовлен из матового стекла пирекс.





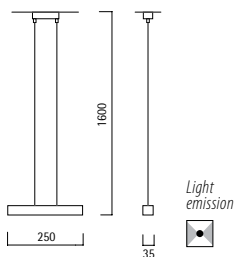

Lampada sospensione - *Pendant lamp*  
**000115** Bianco opaco - *Matt white*  
 LED 2x6W 3.000°K  
 CE V IP30

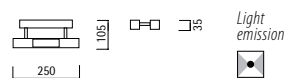

Lampada da parete - *Wall lamp*  
**000118** Bianco opaco - *Matt white*  
 LED 2x6W 3.000°K  
 CE V IP30

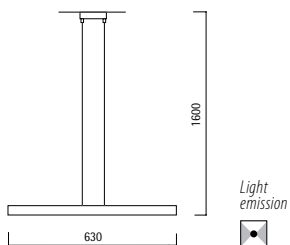

Lampada sospensione - *Pendant lamp*  
**000116** Bianco opaco - *Matt white*  
 LED 4x6W 3.000°K  
 CE V IP30



Lampada da parete - *Wall lamp*  
**000119** Bianco opaco - *Matt white*  
 LED 4x6W 3.000°K  
 CE V IP30

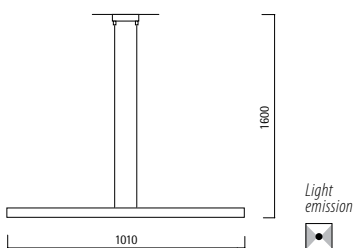

Lampada sospensione - *Pendant lamp*  
**000117** Bianco opaco - *Matt white*  
 LED 6x6W 3.000°K  
 CE V IP30

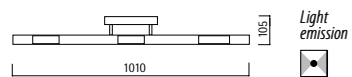

Lampada da parete - *Wall lamp*  
**000120** Bianco opaco - *Matt white*  
 LED 6x6W 3.000°K  
 CE V IP30

# MAX LED





**Sospensione a luce diffusa composta da 19 elementi in metallo che richiamano la forma elicoidale e che, dal centro della lampada dove si trova la sorgente luminosa, si irradiano verso l'esterno. La loro composizione appare geometrica e ordinata, da certi punti di vista, dinamica e casuale da altri. La fonte luminosa è al centro, contenuta all'interno di un vetro soffiato opale. Disponibile nei colori verniciato bianco lucido e rosso.**

Diffused light pendant made up of 19 metal coils spreading out from the globe with the lamp in the centre outward. The design is neat and geometrical at the same time looking vibrant and random. The lamp is inside the opal blown glass in the centre. Available finishes: glossy white and red painted.

Suspension à lumière diffuse composée de 19 formes hélicoïdales en métal. Un globe en verre est situé au centre, duquel partent ces formes géométrique à la fois dynamique et aléatoires. Le globe au centre est en verre soufflé opalin. Disponible en blanc ou rouge brillant.

Hängeleuchte mit diffusem Licht. Die Struktur besteht aus 19 Metallelementen, die eine Spirale bilden und von der Mitte der Leuchte aus, wo sich die Lichtquelle befindet, nach außen strahlen. Ihre Anordnung wirkt aus manchen Blickwinkeln geometrisch und geordnet, aus anderen dynamisch und zufällig. Die Lichtquelle befindet sich in geblasenem Opalglas. Oberfläche: Weiße oder rote Lackierung.

Lámpara suspendida a luz difusa con 19 elementos de metal de forma helicoidal que dal centro van estendendose hacia l'exterior. La composición de los elementos es geométrica y ordenada y nel mismo tiempo dinámica y casual. La bombilla está al centro dentro un vidrio soplado mate. Disponible en los colores blanco brillo y rojo.

Подвесной светильник состоит из 19-ти спиралевидных металлических элементов и центральной части, где расположен источник света который заключен в шар из матового дутого стекла. Спирали могут быть окрашены в блестящий белый или красный цвет.



**Bianco lucido**  
Glossy white



**Rosso lucido**  
Glossy red

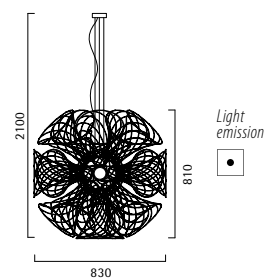

Lampada sospensione - Pendant lamp

**013175** Bianco lucido - Glossy white

**013176** Rosso lucido - Glossy red

E27 1x105W A55

E27 1x100W QT-32

CE









# VITA

design Brian Rasmussen 2011





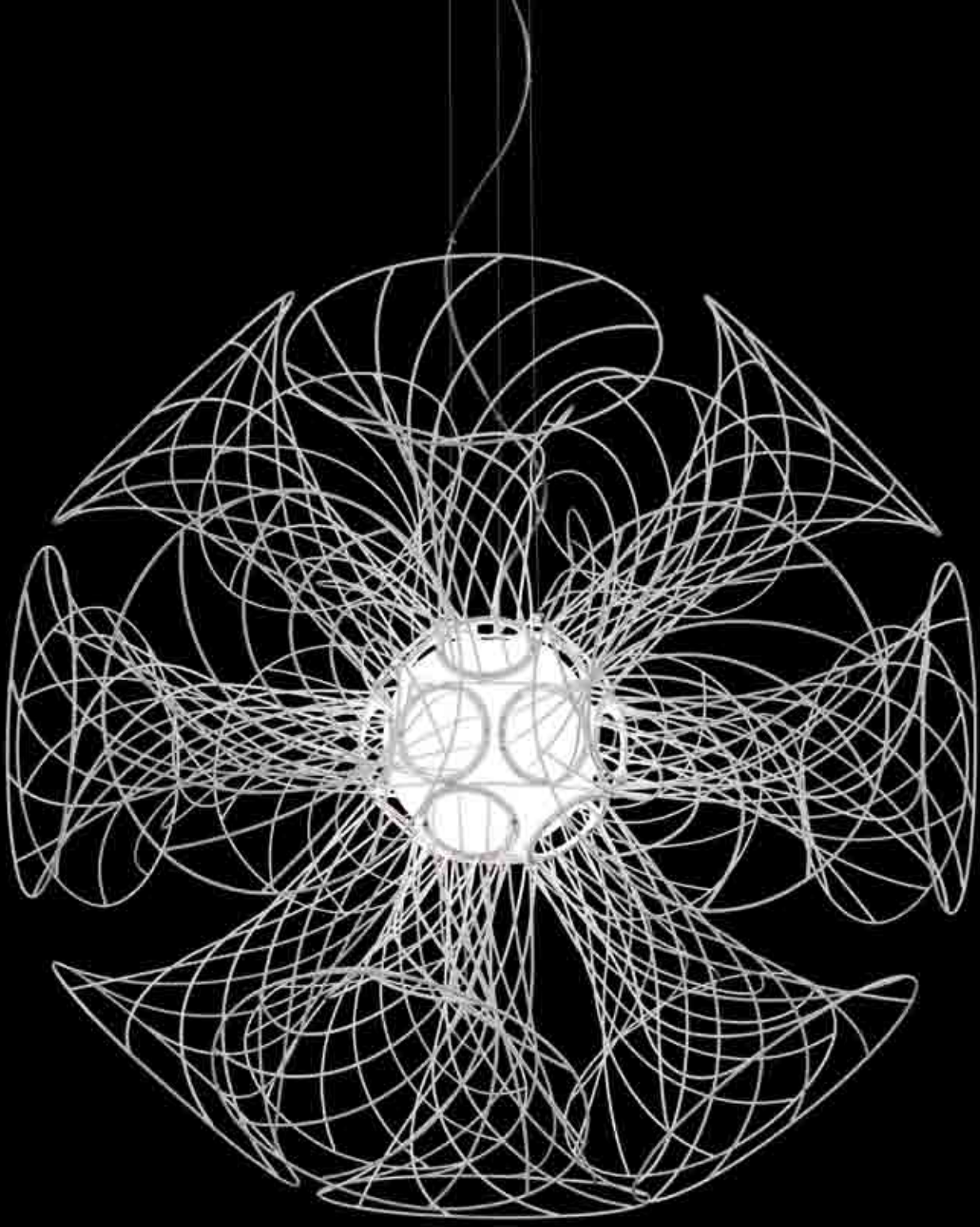



VITA

design Brian Rasmussen 2011

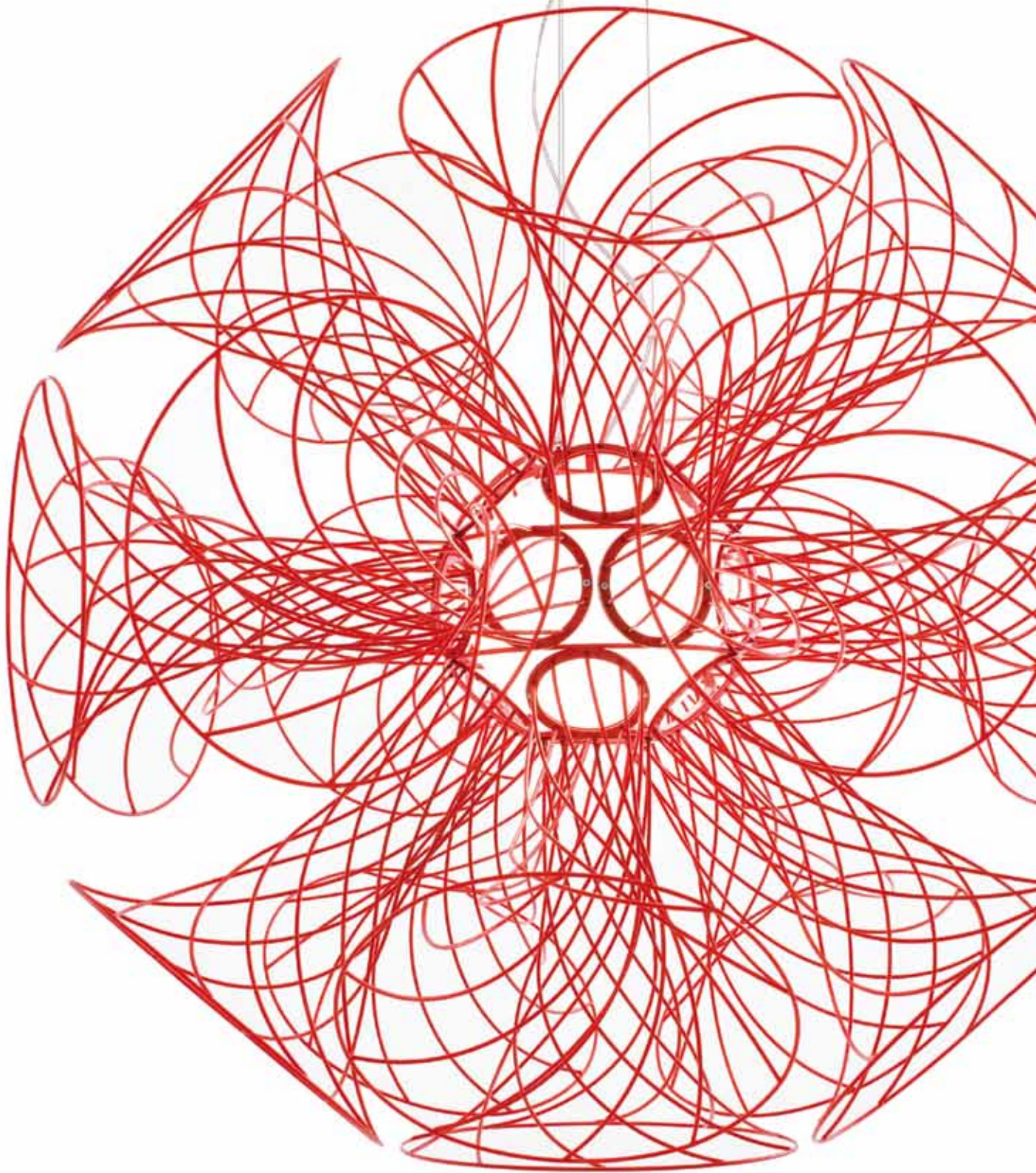

**Struttura in metallo verniciato in diverse varianti. Parte inferiore chiusa da un disco in metacrilato prismatico trasparente che permette una resa luminosa ottimale. Alimentazione elettronica.**

Painted metal structure with transparent prismatic acrylic disc underneath for a perfect light emission. Electronic ballast.

Structure en métal verni avec un disque acrylique transparent prismatique pour une émission de lumière parfaite. Ballast électronique.

Hänge- oder Deckenleuchte mit direktem oder diffusem Licht. Die Metallstruktur wird unten von einer prismatischen, transparenten Methacrylat-Scheibe umschlossen, die für optimale Lichtausbeute sorgt. Elektronische Stromversorgung.

Estructura metálica pintada, cerrada con un difusor en metacrilato prismático transparente que difunde la luz en manera optimal. Ballast electrónico.

Металлический корпус закрыт снизу рассеивателем из призматического прозрачного метакрилата, благодаря которому достигается оптимальный световой поток. Имеется встроенный электронный балласт.

curve fotometriche disponibili photometrics available 



**Bianco - Bianco**  
White - White



**Bianco - Arancio**  
White - Orange







**Rosso - Bianco**  
Red - White

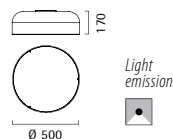

**Nero - Bianco**  
Black - White



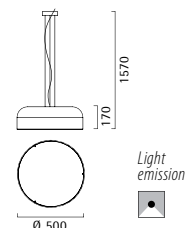

Lampada da soffitto - Ceiling lamp

**012105** Bianco/Bianco - White/White  
**012106** Bianco/Arancio - White/Orange  
**012107** Rosso/Bianco - Red/White  
**012108** Nero/Bianco - Black/White  
 2GX13 40+22W T5c   
   



Sospensione - Pendant lamp

**012101** Bianco/Bianco - White/White  
**012103** Bianco/Arancio - White/Orange  
**012104** Rosso/Bianco - Red/White  
**012109** Nero/Bianco - Black/White  
 2GX13 40+22W T5c   
   















**Lampada da terra realizzata in polietilene colore avorio tramite la tecnologia dello stampaggio rotazionale. La lampada è disponibile sia nella versione da interno che da esterno (IP44). Nella versione da interno sono disponibili degli accessori in lana lavorata a coste nei colori beige oppure rosso, da mettere come rivestimento al paralume. Nella versione da interno la base e il paralume possono avere un'accensione separata e dimerabile.**

Ivory polyethylene floor lamp made with the rotational moulding technology. Available for indoor and outdoor (IP44) application. On the indoor version a wool cover for the diffuser is available in cream and red. On the indoor version the stem and the diffuser have separate dimmable switches.

Lampadaire en polyéthylène, coloris ivoire, réalisé grâce à une technique de moulage rotatif. Disponible pour intérieur ou extérieur (IP44). Pour le modèle d'intérieur, une étoffe de laine est disponible pour être rajouté à l'abat-jour, de couleur rouge ou crème. Pour la version d'intérieur, l'allumage peut être séparé est composé de deux variateurs, l'un pour le corps et le second pour l'abat-jour.

UP ist eine große Bodenleuchte für den Innen- und Außenbereich (Version IP44), die im Rotoformverfahren vollständig aus Polyäthylen gefertigt wurde. Die Basis und der Lampenschirm können gleichzeitig oder getrennt voneinander beleuchtet werden. Die Lampe ist in Elfenbeinweiß erhältlich. Bei der Version für den Innenbereich ist als Überzug des Lampenschirms ein beige oder rotes geripptes Wollteil mit einem Durchmesser von 60 Zentimetern erhältlich.

Lámpara de pie hecho en polietilene color marfil con la técnica del moldeo rotacional. La lámpara es disponible en la versión para interior o en la versión para exterior (IP44). En la versión para interior son disponibles accesorios en lana rojo o beige como decoración por la pantalla. Para la versión de interiores la base y la pantalla pueden iluminarse de forma independiente y regulable.

Корпус этого напольного светильника изготовлен из полиэтилена цвета слоновой кости методом ротационного формования. Светильник может быть как внутренним, так и уличным (IP44). Для внутренней модели предлагаются дополнительные вязанные из шерсти аксессуары бежевого или красного цвета. Их можно надевать на верхнюю, цилиндрическую часть светильника, имеющую диаметр 60 см. У внутренних светильников конусообразное тело и цилиндрический верх могут диммироваться и иметь раздельное включение.



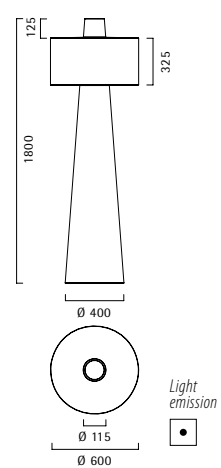

**Versione da esterno IP44 - on/off**

Outdoor IP44 - on/off

Lampada da terra - Floor lamp

**012028** Avorio - Ivory

Base - Base E27 4x17W TC-TSE ton.825 

Diffusore - Diffuser E27 1x30W TC-TSE ton.825 

E27 1x150W QT-32 

UP IP44  
design Mario Mazzer 2011







UP IP44  
design Mario Mazzer 2011







UP IP20  
design Mario Mazzer 2011



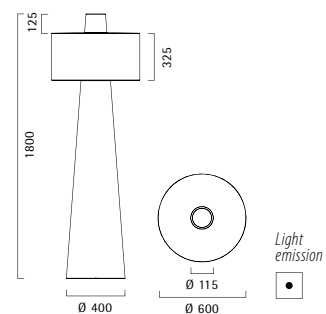

**Versione da interno IP20. Accensione separata per base e diffusore. Dimmer per diffusore.**  
 Indoor IP20 - Separate switches for base and diffuser.  
 Dimmable lamp within the diffuser.

Lampada da terra - Floor lamp

**012029** Avorio - Ivory

Base - Base E27 4x17W TC-TSE ton.825

Diffusore - Diffuser E27 1x150W QT-32

CE IP20

**Versione da interno IP20 DALI. Accensione separata per base e diffusore. Dimmer per base (DALI) e diffusore.**

Indoor IP20 DALI - Separate switches for base and diffuser.  
 Dimmable lamps within the base (DALI) and the diffuser.

Lampada da terra - Floor lamp

**012030** Avorio - Ivory

Base - Base G5 2x28W T5 ton.827

Diffusore - Diffuser E27 1x150W QT-32

CE IP20

**Accessorio in lana per versione da interno**  
 Wool cover for indoor version



**022102**  
 Beige - Cream



**022103**  
 Rosso - Red



UP

design Mario Mazzer 2011







# SEMJASE

design Sandro Santantonio Design 2010

**Lampada da terra in poliuretano espanso strutturale stampato a iniezione. Finitura verniciato bianco lucido con particolare della base in grigio lucido.**

Injection-moulded foam polyurethane floor lamp. Glossy white painted with glossy grey detail on the base.

Lampadaire en polyuréthane expansé structurel procédé par injection. Finition verni blanc brillant avec les détails de la base en gris brillant.

Stehleuchte in Polyurethan Schaumstoff gepresst mit strukturierter Oberfläche in weiss glänzend und als Besonderheit ein grau glänzender Fuß.

Lampara de pie en poliuretano expandido estructural estampado a inyección. Acabado barnizado blanco brillo con base en gris brillo.

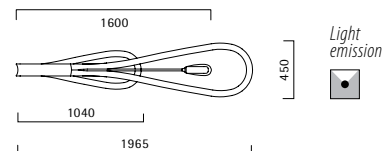
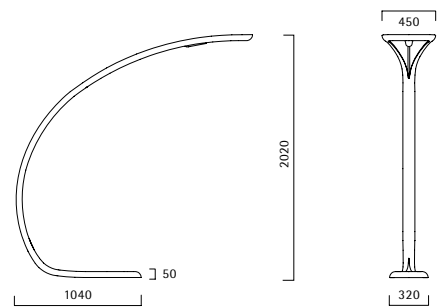

Белый глянцевый корпус выполнен из полиуретана с серыми деталями на базе.



Lampada da terra - Floor lamp  
Bianco - White

**007720**

R7s 118mm 1x230W QT-DE 





# SEMJASE

design Sandro Santantonio Design 2010







# SEMJASE

design Sandro Santantonio Design 2010



# ARUM

design Sandro Santantonio Design 2009

**Lampada da terra con struttura metallica verniciata bianca opaca e rivestimento in tessuto elasticizzato sfoderabile e lavabile. Tessuto disponibile nei colori avorio oppure rosso.**

Floor lamp. Matt white metal structure, removable and washable stretch-fabric available in ivory and red.

Lampe de terre avec structure blanche opaque vernie métallique et revêtement en tissu élastique amovible et lavable.  
Tissu disponible en ivoire ou rouge.

Stehleuchte mit Metalstruktur in weiss matt lackiert und mit einem waschbaren und austauschbarem elastischem Gewebe ummantelt. Das Gewebe ist in den Farben elfenbein und rot erhältlich.

Lámpara de pie. Estructura metálica barnizada blanca revestida de tejido elástico y lavable. Tejido disponible en los colores marfil y rojo.

Торшер. Матовое белое металлическое основание, ткань красного или песочного цвета, которую можно снять и постирать по необходимости.

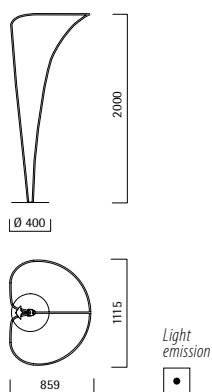

Lampada da terra - Floor lamp

**017770** Avorio - Ivory

**017771** Rosso - Red

Superiore - Top E27 1x205W QT-32 

Inferiore - Bottom GU10 1x50W QPAR 



**Rosso**  
Red



**Avorio**  
Ivory







# ARUM

design Sandro Santantonio Design 2009





# ARUM

design Sandro Santantonio Design 2009





# EIGHT 1000

design Sandro Santantonio Design 2009

**Lampada con struttura metallica e rivestimento in tessuto elasticizzato sfoderabile e lavabile. Tessuto disponibile nei colori avorio oppure arancio.**

Metal structure and removable and washable stretch-fabric available in ivory and orange.

Lampe avec structure métallique et revêtement en tissu élastique amovible et lavable. Tissu disponible en ivoire ou orange.

Leuchte mit Metalstruktur in weiss matt lackiert und mit einem waschbaren und elastischem Gewebe ummantelt. Das Gewebe ist in den Farben elfenbein oder orange erhältlich.

Estructura metálica barnizada revestida de tejido elástico, desenfundable y lavable. Tejido disponible en los colores marfil y anaranjado.

Металлическое основание, ткань белого или оранжевого цветов, которую можно снять и постирать по необходимости.



**Avorio**  
Ivory



**Arancio**  
Orange

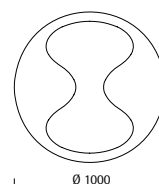
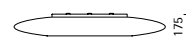

Light  
emission

Lampada da parete/soffitto - Wall/ceiling lamp

**008900** Avorio - Ivory

**008901** Arancio - Orange

E27 5x21W TC-TSE

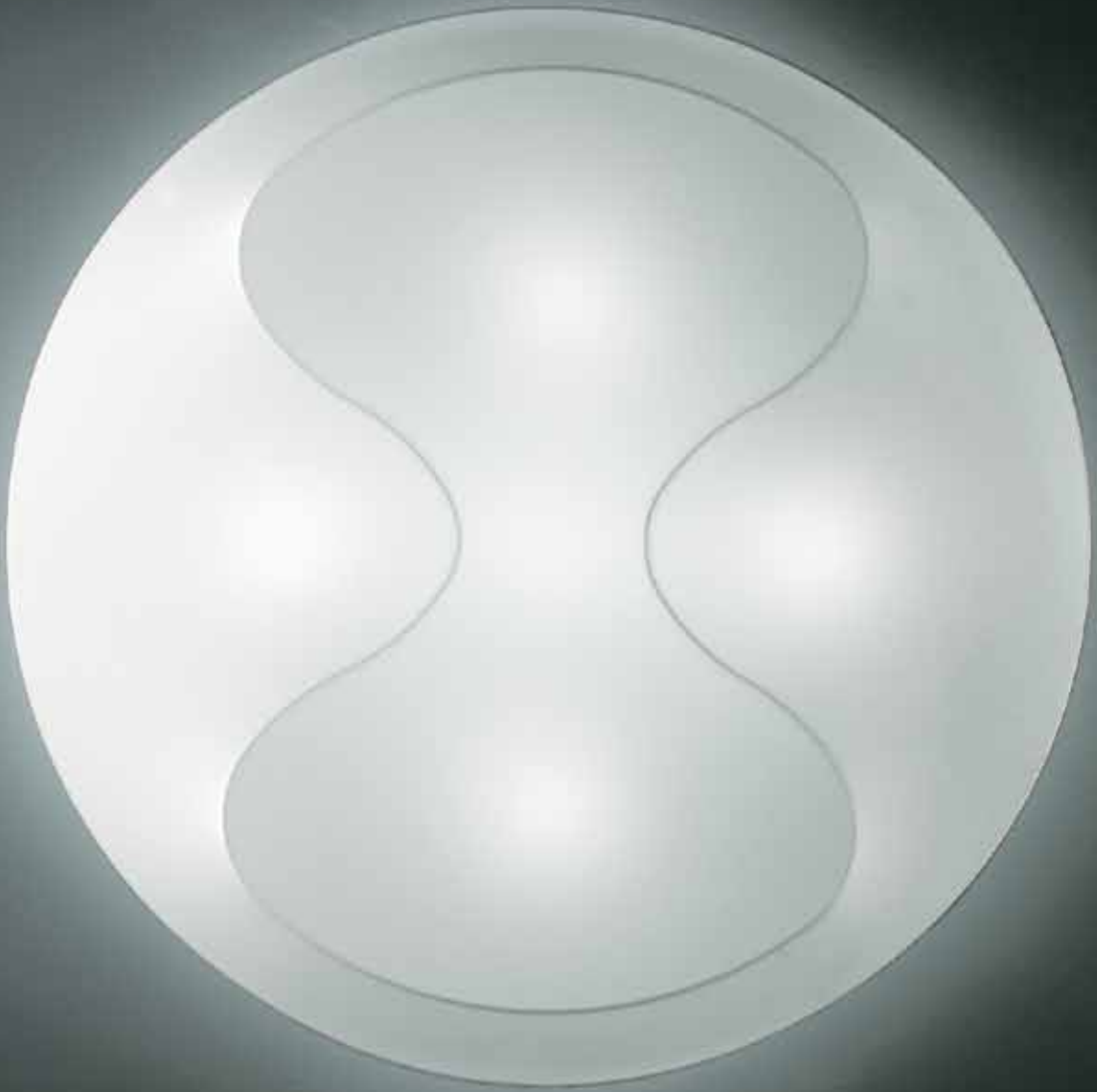

# KAT

design Lucente Lab

**Lampada da parete a led in metallo verniciato bianco, plexiglass frontale per una migliore diffusione della luce. Led dimerabile e a tensione di rete.**

LED wall lamp in white painted metal and Plexiglas for optimal light diffusion. Dimmable.

Applique LED avec variateur en métal blanc verni. Plexiglass pour une meilleure diffusion de la lumière.

LED Wandleuchte aus Metall weiß gestrichen und Plexiglas für eine optimale Lichtstreuung. Dimmbare LEDs.

Lámpara de pared Led de metal pintado blanco, plexiglass frontal para una mejor difusión de la luz. Led regulable en tensión de línea.

Настенный светильник со светодиодами. Корпус выполнен из металла, окрашенного в белый матовый цвет, а рассеиватель из плексиглаза позволяет достигнуть лучшего распределения светового потока. Диммируемый. Трансформатор идет в комплекте.

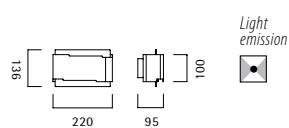

Lampada da parete - Wall lamp

**015625** Bianco opaco - Matt white

LED 2x13W 3.000°K dimerabile - dimmable

CE   





# VERSO

design Mario Mazzer 2012

**Questa lampada a forma trapezoidale nasce dalla parete e si espande verso l'esterno con una luce riflessa. Verso esprime una visione di continuità tra parete e luce, espandendo lo spazio verso l'esterno con un'illuminazione fluida. Struttura in alluminio, illuminazione a LED tonalità Natural White 4100°K e Warm White 3000°K. Alimentatore incluso.**

Irregular shaped wall fitting, jutting from the wall and spilling indirect light outwards. Aluminium structure. LED temperature is Natural White 4100°K and Warm White 3000°K. Ballast included.

Lampe de forme trapézoïdale, qui part de l'idée de faire naître la lumière du mur, et de la projeter vers l'extérieur grâce à une forme qui crée une sorte de continuité entre la source de lumière et le mur. Réalisée en aluminium peint en blanc opaque, cette lampe peut être fixée selon des orientations différentes. Eclairage à LED température blanc naturel 4100°K et blanc chaud 3000°K. Alimentation incluse.

Trapezförmige Lampe, für die die Idee Pate stand, das Licht aus der Wand heraus entstehen zu lassen und dieses nach außen zu projektieren und zwar dank einer Form, durch die eine Art Durchgängigkeit zwischen Leuchtquelle und Wand entsteht. Hergestellt ist sie aus matt glänzend lackiertem Weiß, die Lampe kann unterschiedlich ausgerichtet montiert werden. Lichtquelle: LED in Lichtfarbe NW 4100°K und in WW 3000°K. Der Konverter ist inklusive.

Lámpara con forma trapezoidal nacida con la idea de hacer surgir la luz de la pared y proyectarla hacia el exterior gracias a una forma que crea una especie de continuidad entre la fuente luminosa y la propia pared. Realizada en aluminio pintado de blanco mate, la lámpara se puede fijar a la pared orientándola en diversas direcciones. Iluminación con LED tonalidad blanco natural 4100°K y blanco cálido 3000°K. Alimentador incluido.

Настенный светильник трапецеидальной формы, который несет идею рождения света от стены и его отражения наружу благодаря форме, которая создает своеобразную непрерывность между источником света и самой стеной. Светильник, выполненный из матового белого алюминия.

Используются две светодиодные лампы 6 Вт 220-240. тональности (на выбор теплого 3000°K или холодного 4100°K света). Имеется встроенный электронный балласт.

curve fotometriche disponibili photometrics available 

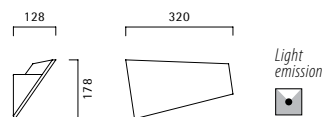

Lampada da parete - Wall lamp  
Bianco opaco - Matt white

**016360** LED 2x6W 3.000°K

**016361** LED 2x6W 4.100°K



# VERSO

design Mario Mazzer 2012







# ELETTA

design Lucente Lab

**Lampada da parete caratterizzata da una forma ovale. La parte frontale è in alluminio verniciato bianco opaco sovrapposta da una parte in plexiglass trasparente lucido che ne segue la forma, crea un contorno luminoso e una luce indiretta e diffusa. Illuminazione LED tonalità Natural White 4100°K e Warm White 3000°K. Alimentatore incluso.**

Oval wall lamp. The front is matt white painted aluminium. A transparent gloss Perspex diffuser is fixed onto it and makes a diffuse indirect light. LED Natural White 4100°K and Warm White 3000°K. Ballast included.

Lampe murale caractérisée par sa forme ovale. La partie frontale est en aluminium peint en blanc opaque, et l'arrière est réalisé en plexiglas transparent brillant, de façon à créer un contour lumineux et une lumière indirecte et diffuse. Eclairage à LED température blanc naturel 4100°K et blanc chaud 3000°K. Alimentateur incluse.

Wandlampe in ovaler Form. Der vordere Teil ist aus matt weiß lackiertem Aluminium und die Rückseite aus durchsichtigem glänzendem Plexiglas. Es entsteht der Eindruck eines leuchtenden Rahmens. Das Licht ist indirekt und diffus. Leuchtquelle: LED Natural White 4100°K sowie Warm White 3000°K. Der Konverter ist inklusive.

Lámpara de pared con una característica forma oval. La parte frontal está realizada en aluminio pintado de blanco mate y la posterior en plexiglás transparente brillante, de modo que crea un contorno luminoso y una luz indirecta y difusa. Iluminación con LED tonalidad blanco natural 4100°K y blanco cálido 3000°K. Alimentador incluido.

Настенный светильник, характеризуемый овальной формой. Передняя часть выполнена из матового, окрашенного в белый цвет алюминия, а задняя часть из прозрачного блестящего оргстекла, для воспроизведения ярких очертаний и непрямого, рассеянного света. Используются две светодиодные лампы 6 Вт 220-240. тональности на выбор теплое 3000°K или холодное 4100°K света. Блок питания включен в комплект.



curve fotometriche disponibili photometrics available 

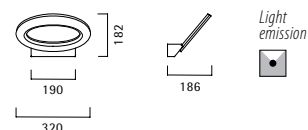

Lampada da parete - Wall lamp  
Bianco opaco - Matt white

**015620** LED 2x8,5W 3.000°K

**015621** LED 2x8,5W 4.100°K

CE  IP 20  P 







**Lampade dal design minimalista ed elegante, con una vocazione per la sostenibilità: la luce è prodotta da una fonte luminosa a led. Alluminio verniciato bianco opaco e plexiglas trasparente lucido che conduce lievemente la luce. Alimentatore incluso.**

Lamps featuring a minimalist and refined design and highly sustainable. Matt white painted and transparent gloss Perspex which enhances the light diffusion. Ballast included.

Lampes avec un design raffiné et minimaliste. La partie frontale est en aluminium mat blanc avec une partie à l'arrière en plexi transparent et conducteur de lumière. Alimentation incluse.

Leuchten in minimalistischem und elegantem Design, umweltbewusst entwickelt: das indirekte Licht wird von einer LED-Lampe erzeugt, die einen sparsamen Energieverbrauch sicherstellt. Die Front besteht aus mattweiß lackiertem Aluminium, das auf einer Seite von glänzend transparentem und leicht lichtleitendem Plexiglas bedeckt ist. Der Konverter ist inklusive.

Lámparas con diseño minimalista y elegante altamente sostenibles: la luz es producida por una fuente luminosa LED. De aluminio pintado blanco mate y plexiglás transparente brillante que guía suavemente la luz. Alimentador incluido.

Светильники с минималистским и элегантным дизайном, источник света LED. Корпус выполнен из алюминия, окрашен в белый матовый цвет. Рассеиватель из прозрачного плексигласа. Блок питания включен в комплект.

curve fotometriche disponibili photometrics available 

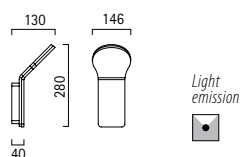

Lampada da parete - Wall lamp  
Bianco opaco - Matt white

**015610** LED 7x1,8W 3.000°K

**015611** LED 7x1,8W 4.100°K

CE    IP 20

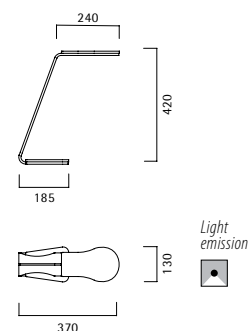

Lampada da tavolo - Table lamp  
Bianco opaco - Matt white

**015612** LED 3,6W 4.100°K

CE  IP 20



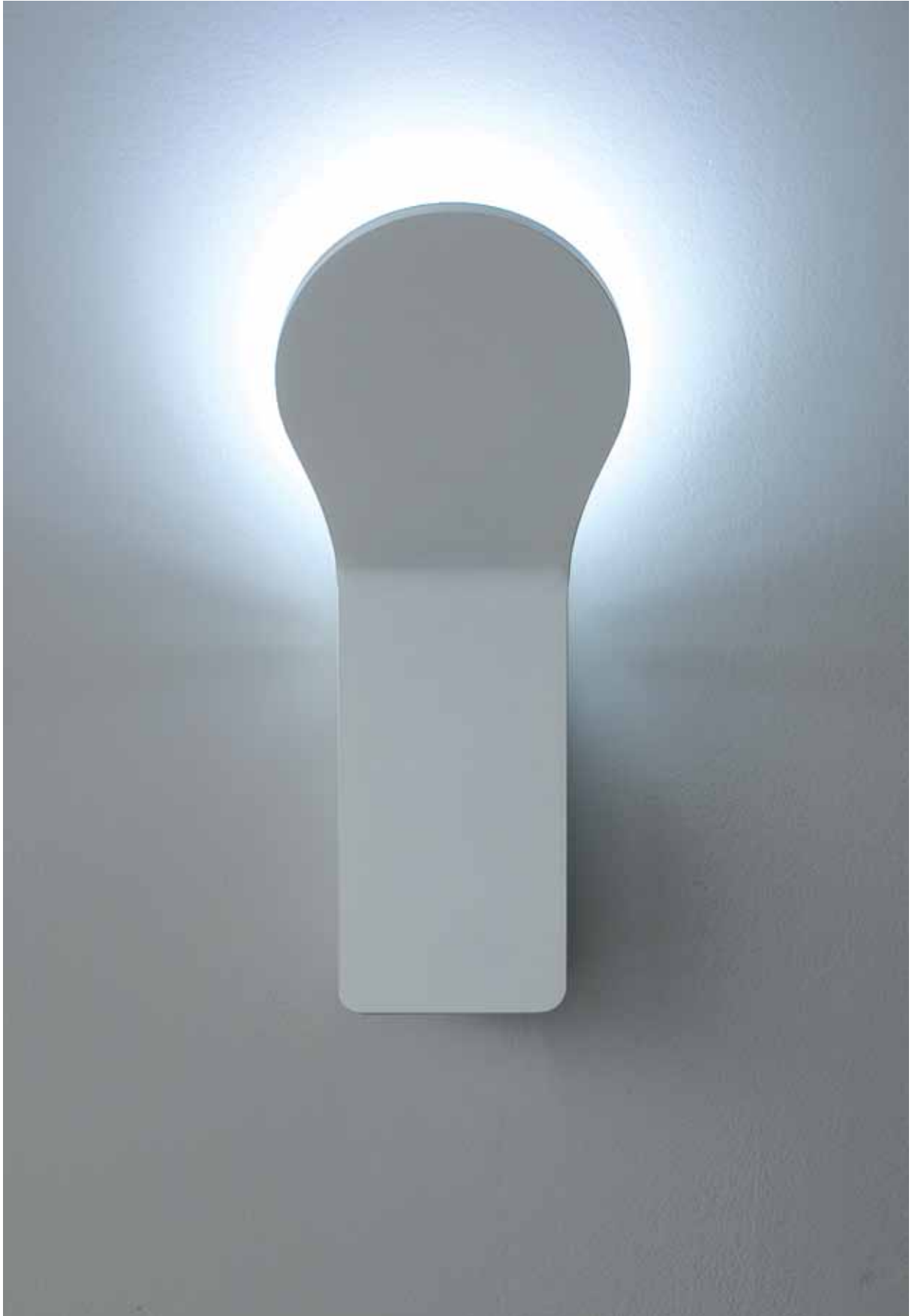





CLIVIA







# KALYPSO IP44

design Paolo De Lucchi 2010

**Serie in alluminio pressofuso, finitura cromo. La lampada da parete è dotata di braccio flessibile cromato orientabile a 360°. Alimentatore incluso. Grado di protezione IP44. Illuminazione Led 3,6W 220-240V 50-60Hz tonalità Natural White 4100°K e Warm White 3000°K.**

Chrome die cast aluminium lamps. The wall lamp is provided with a chrome swing 360° arm. Ballast included. IP44 rated. 3,6W LED. 220-240V 50-60Hz Natural White 4100°K and Warm White 3000°K.

Séries en fonte d'aluminium finition chrome. L'applique est dotée d'un bras flexible chromé orientable à 360°.

Alimentation incluse. Protection IP44. Source led 3.6W 220-240V 50-60Hz – Température blanc naturel 4100°K et blanc chaud 3000°K.

Serie aus verchromten Alu-Pressprofil. Die Wandleuchte ist mit einem verchromten, 360° schwenkbaren Arm bestückt. Der Konverter ist inklusive. Schutzart IP 44. Bestückung: LED 3,6W 220-240V 50-60 Hz in Lichtfarbe NW 4100°K und in WW 3000°K.

Serie realizada en aluminio vaciado por presión, acabado cromo. La Lámpara de pared está dotada de un brazo flexible cromado y orientable a 360°. Alimentador incluido. Grado de protección IP44. Iluminación Led 3,6W 220-240V 50-60Hz tonalidad blanco natural 4100°K y blanco cálido 3000°K.

Хромированные литые алюминиевые светильники с возможностью направления светового потока в любую сторону. IP44. LED 4100°K белый цвет, 3000°K. Балласт в комплекте.

curve fotometriche disponibili photometrics available 

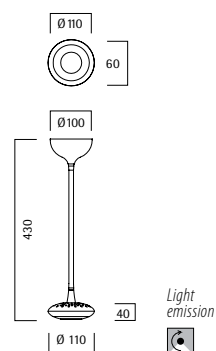

Lampada da parete/soffitto - Wall/ceiling lamp  
Cromo - Chrome

**015601** LED 3,6W 4.100°K

**015602** LED 3,6W 3.000°K

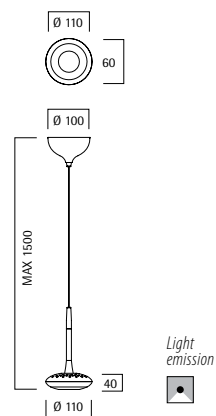

Lampada sospensione - Pendant lamp  
Cromo - Chrome

**015600** LED 3,6W 4.100°K

**015604** LED 3,6W 3.000°K



KALYPSO IP44  
design Paolo De Lucchi 2010





Lancia è una lampada a sospensione dalla forma sinuosa e allungata, composta da due fogli di metallo verniciati bianco opaco sovrapposti, piegati e curvati. La sospensione si può installare a piacimento sia con la luce rivolta verso l'alto che verso il basso, il diffusore superiore è in pmma satinato. Alimentazione elettronica.

Oblong shaped pendant lamp with sleek, elegant lines, made up of two curved metal sheets. Matt white painted. Installation is possible with the lamp creating either direct or indirect lighting effect. Top diffuser is satin PMMA. Electronic ballast.

Lancia est une lampe à suspension, de forme sinueuse et allongée, composée de deux feuilles en métal, peintes en blanc, superposées, pliées et recourbées. On peut installer la suspension à son propre gré, avec la lumière orientée soit vers le haut, soit vers le bas; le diffuseur supérieur est en PMMA satiné. Ballast électronique.

Lancia ist eine Hängelampe mit einer länglichen gewundenen Form. Sie setzt sich aus zwei Metallblättern zusammen. Sie sind weiß lackiert, übereinander angeordnet, gebogen und gewunden. Sie kann je nach Wunsch mit nach oben oder unten gerichteten Leuchten montiert werden. Der obere Lichtschirm ist aus satiniertem PMMA. Elektronische Stromversorgung.

Lancia es una lámpara de colgar, de forma sinuosa y alargada, compuesta por dos hojas de metal, pintado de blanco, superpuestas, plegadas y curvadas. Se puede colgar según gustos, tanto con la luz hacia arriba como con ella hacia abajo, ya que el difusor superior está realizado en PMMA satinado. Ballast electrónico.

Подвесной светильник извилистой и вытянутой формы, состоящий из двух металлических листов наложенных друг на друга, окрашенных в белый цвет. Светильник может быть подвешен как с лампой направленной вверх, так и вниз, верхний диффузор выполнен из сатинированного PMMA. Рассеиватель из прозрачного плексигласа, электронный балласт включен в комплект.

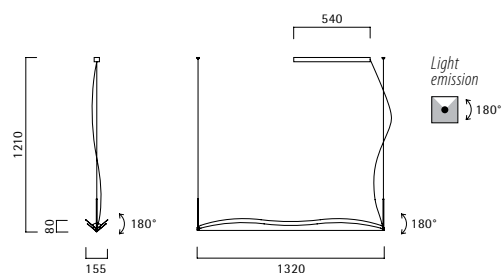

Lampada sospensione - Pendant lamp  
**012680** Bianco opaco - Matt white  
 G5 1x54W T5  
 CE V IP20 P





LANCIA





# WEDGE

design Paolo De Lucchi 2008

## Lampada orientabile in cristallo pressato. Finiture in cromo.

Adjustable lamps. Clear pressed crystal glass. Chrome finishes.

Structure orientable en métal laqué.  
Difuseur en verre crystal pressé.

Drehbar Struktur aus lackiertem Metall.  
Chrystal glas.

Lámpara orientable en cristal prensado. Acabados en cromo.

Прозрачное стекло.  
Хромовое покрытие.

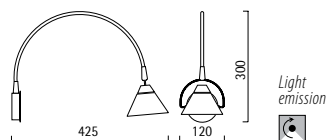

Lampada da parete - Wall lamp  
Cromo - Chrome

**015702**

GU10 1x75W QPAR

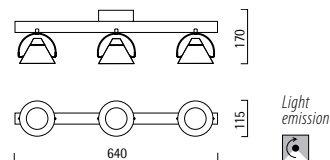

Lampada da parete / soffitto - Ceiling / Wall lamp  
Cromo/Alluminio anodizzato - Chrome/Anodized aluminium

**015704**

GU10 3x75W QPAR

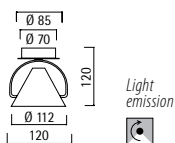

Lampada da parete - Wall lamp  
Cromo - Chrome

**015700**

GU10 1x75W QPAR

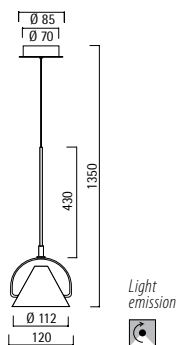

Lampada sospensione - Pendant lamp  
Cromo - Chrome

**015701**

GU10 1x75W QPAR

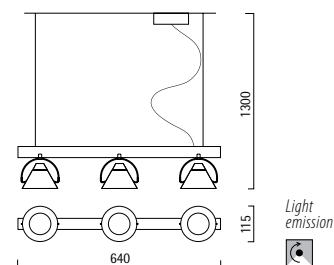

Lampada sospensione - Pendant lamp  
Cromo/Alluminio anodizzato - Chrome/Anodized aluminium

**015703**

GU10 3x75W QPAR









# WEDGE

design Paolo De Lucchi 2008







WEDGE  
design Paolo De Lucchi 2008



# WEDGE

design Paolo De Lucchi 2008





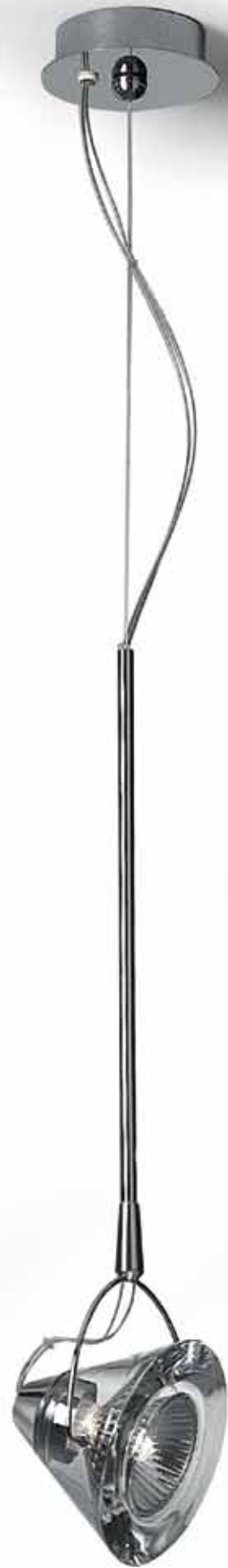
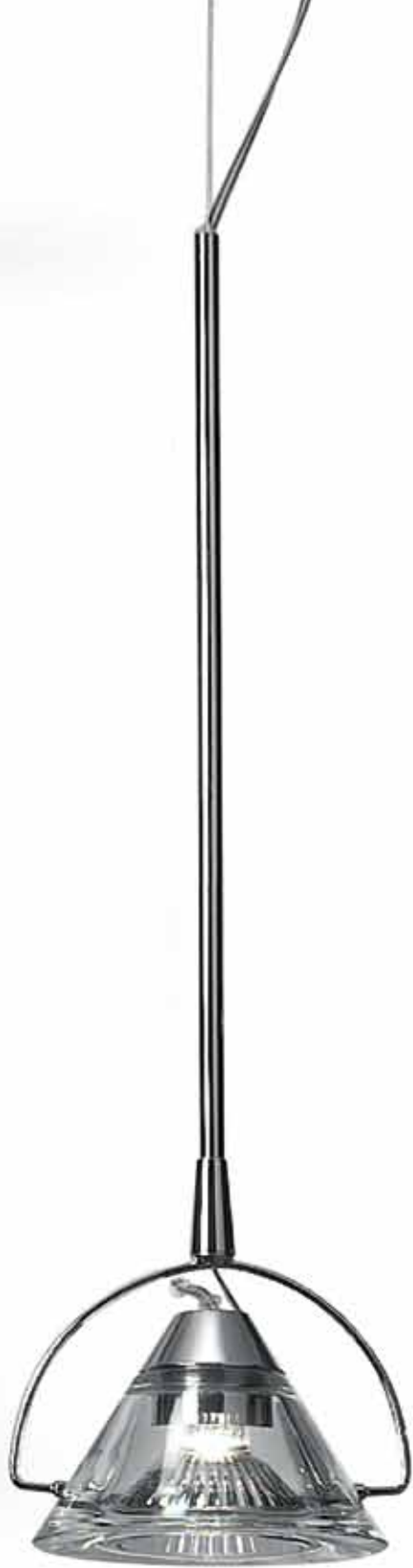

# CYCLOS

design NORWAY SAYS, Torbjørn Anderssen, Andreas Engesvik, Espen Voll 2005

**Corpo esterno in alluminio verniciato a polvere nei colori bianco oppure grigio argento e parte interna diffondente in metacrilato opalino lucido. Alimentazione elettronica.**

Outer body made of white or silver grey powder coated aluminium and inner diffusing body made of glossy opaline methacrylate. Electronic ballast.

Corps externe en aluminium laqué à la peinture en poudre dans les coloris blanc ou gris argent et partie interieure diffusante en méthacrylate opalin brillant. Ballast électronique.

Externer Leuchtenkörper aus Aluminium, Pulverlackierung in den Farben weiß oder silbergrau, Diffusor innen aus glänzend-opakem Metacrylat. Elektronische Stromversorgung.

Cuerpo externo de aluminio barnizado a polvo en color blanco o gris plateado, y parte interior difusora de metacrilato opalino brillante. Ballast electrónico.

Белый или серый алюминиевый корпус. Белый глянцевый рассеиватель из метакрилата. Электронный балласт.

curve fotometriche disponibili photometrics available 

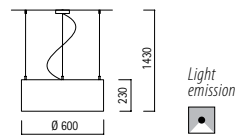

Lampada sospensione - *Pendant lamp*

**012088** Bianco - *White*  
**012087** Grigio argento - *Silver grey*  
 G24q-3 5x26W TC-DE   
   

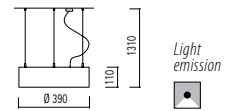

Lampada sospensione - *Pendant lamp*

**012072** Bianco - *White*  
**012073** Grigio argento - *Silver grey*  
 2GX13 1x55W T5c   
   

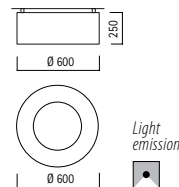

Lampada da soffitto/parete - *Ceiling/wall lamp*

**012069** Bianco - *White*  
**012068** Grigio argento - *Silver grey*  
 G24q-3 5x26W TC-DE   
   

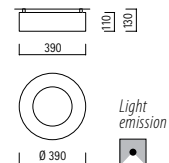

Lampada da soffitto/parete - *Ceiling/wall lamp*

**012070** Bianco - *White*  
**012071** Grigio argento - *Silver grey*  
 2GX13 1x55W T5c   
   

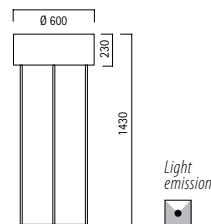

Lampada da terra - *Floor lamp*

**012090** Bianco - *White*  
**012089** Grigio argento - *Silver grey*  
 G24q-3 5x26W TC-DE   
   

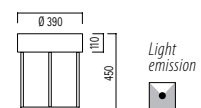

Lampada da tavolo - *Table lamp*

**012078** Bianco - *White*  
**012079** Grigio argento - *Silver grey*  
 2GX13 1x55W T5c   
   





# CYCLOS

design NORWAY SAYS, Torbjørn Anderssen,  
Andreas Engesvik, Espen Voll 2005









# CYCLOS

design NORWAY SAYS, Torbjørn Anderssen,  
Andreas Engesvik, Espen Voll 2005





# CYCLOS

design NORWAY SAYS, Torbjørn Andersen,  
Andreas Engesvik, Espen Voll 2005

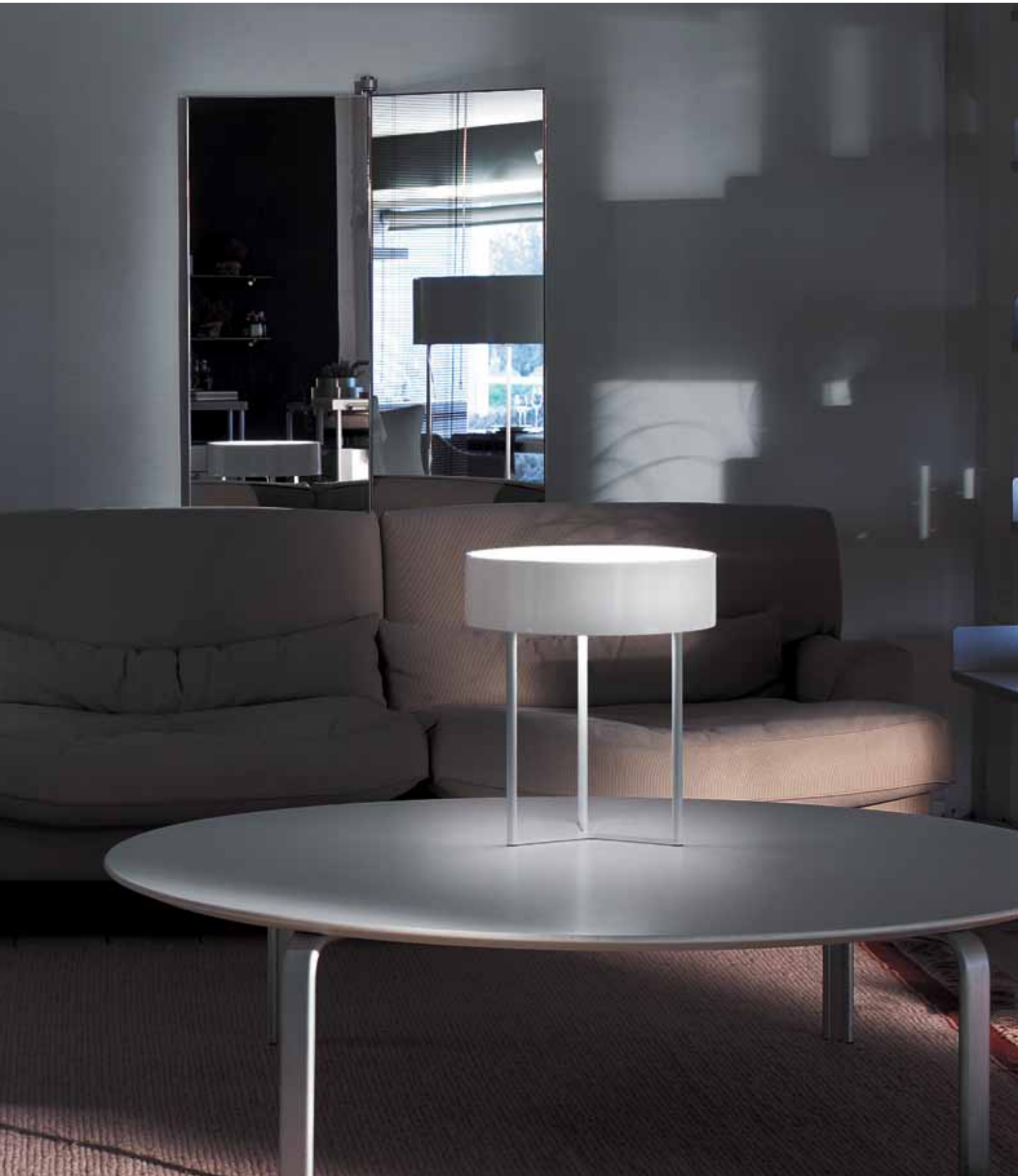

# AERO

design Dodo Arslan 2007

**Struttura in metallo. Vetro soffiato opalino (opalino e incamiciato ambra nella versione sospensione grande) o incamiciato rosso satinato. Nella versione da tavolo, parete e terra opale particolari superiori in vetro a scelta nei colori: rosso, verde, ambra o bianco. Nella versione rosso il particolare è bianco.**

Metal structure. Opal and satin red blown glass diffuser. Amber glass option on the big pendant. The opal glass table, wall and floor lamps have the upper glass details available in red, green, amber and white. All the models with red glass have white details.

Structure en métal. Verre soufflé opalin (opalino et doublé ambre dans la version grande suspension) ou doublé rouge satiné. Dans la version opale de table, murale et de sol, les détails supérieurs en verre peuvent être selon le choix dans les coloris: rouge, vert, ambre ou blanc. Dans les versions «rouge», le détail est blanc.

Struktur aus Metall. Geblasenem Opalglas. (Opal und mit Bernstein verkleidet in der großen Hängeausführung) bzw. rot verkleidet, matt. Bei der Tisch-, Wand- und Bodenausführung Opale kann für die oberen Details aus Glas unter folgende Farben gewählt werden: Rot, Grün, Bernstein oder Weiß. Bei der Ausführung in Rot ist das Detail weiß.

Estructura de metal. Vidrio soplado opalino (opalino y enfundado ámbar en la suspensión grande) o enfundado rojo satinado. En la versión ópalo para mesa, pared y suelo, los detalles superiores de vidrio se pueden elegir en los siguientes colores: rojo, verde, ámbar o blanco. En la versión en rojo el detalle es blanco.

Металлическое основание. Белое и красное дутое стекло. Плафон белого наружного и песочного внутреннего цветов представлен в подвесных светильниках. Стекланные вставки прочно крепятся на магнитах и представлены в красном, зеленом, песочном и белом цветах.





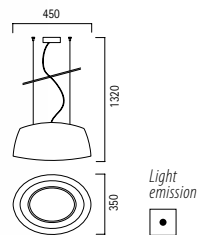

Lampada sospensione - *Pendant lamp*  
Cromo - *Chrome*

**012662** Rosso - *Red*  
**012668** Bianco - *White*  
**012663** Bianco/Ambr - *White/Amber*  
E27 2x52W A55   
CE

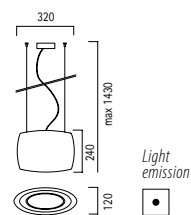

Lampada sospensione - *Pendant lamp*  
Grigio argento - *Silver grey*

**012660** Rosso - *Red*  
**012661** Bianco - *White*  
E27 1x70W A55   
CE

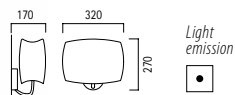

Lampada da parete - *Wall lamp*  
Grigio argento - *Silver grey*

**012666** Bianco - *White*  
**012667** Rosso - *Red*  
E27 1x70W QT-32   
CE

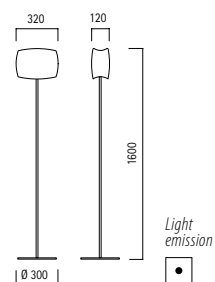

Lampada da terra - *Floor lamp*  
Grigio argento - *Silver grey*

**012670** Bianco - *White*  
**012671** Rosso - *Red*  
E27 1x70W QT-32   
CE

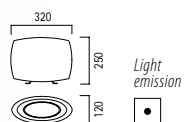

Lampada da tavolo - *Table lamp*  
Grigio argento - *Silver grey*

**012664** Bianco - *White*  
**012665** Rosso - *Red*  
E27 1x70W QT-32   
CE

Codice particolare per lampade da tavolo, parete e terra  
*Upper glass code for table, wall and floor lamps*



**060087** Bianco - *White*



**060086** Ambr - *Amber*



**060084** Rosso - *Red*



**060085** Verde - *Green*



# AERO

design Dodo Arslan 2007





# AERO

design Dodo Arslan 2007





# AERO

design Dodo Arslan 2007





# LOLLYPOP

design Sandro Santantonio Design 2007

**Struttura metallica in nickel spazzolato.**  
**Diffusori in vetro pirex satinato.**

Brushed nickel metal structure.  
 Satin Pyrex diffusers.

Structure métallique nickel brossée.  
 Verre soufflé opalin pyrex.

Struktur aus Nickel gebürstet Metall.  
 Diffusoren aus geblasenem satinierte Pyrex Glass.

Estructura metálica en níquel cepillado.  
 Difusores de vidrio soplado pirex satinado.

Никелированное металлическое основание.  
 Матовое жаростойкое стекло.

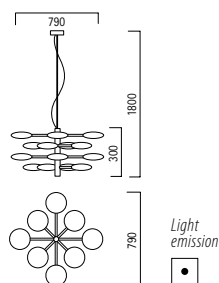

Lampada sospensione - *Pendant lamp*  
 Nickel spazzolato - *Brushed nickel*

**014510**

G9 16x20W QT-13

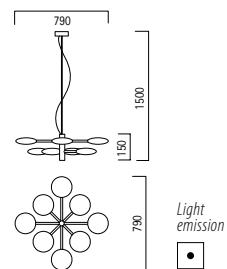

Lampada sospensione - *Pendant lamp*  
 Nickel spazzolato - *Brushed nickel*

**014511**

G9 8x33W QT-13

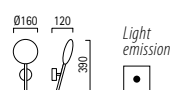

Lampada da parete - *Wall lamp*  
 Nickel spazzolato - *Brushed nickel*

**014513**

G9 1x48W QT-13

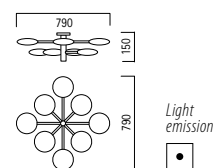

Lampada da soffitto/parete - *Ceiling/wall lamp*  
 Nickel spazzolato - *Brushed nickel*

**014512**

G9 8x33W QT-13









# LOLLYPOP

design Sandro Santantonio Design 2007





# LOLLYPOP

design Sandro Santantonio Design 2007



**Diffusore in vetro soffiato con finitura lucida, disponibile nei colori bianco oppure ambra e con finitura opaca nei colori verde-sabbia oppure rosso-sabbia. Struttura in metallo cromato.**

Blown glass diffuser available in glossy white and amber. Also available in matt sandy-green and sandy-red. Chrome metal structure.

Diffuseur en verre soufflé, finition brillante disponible en blanc ou ambre mais aussi sablonneux verre ou sablonneux rouge. Structure en métal laqué.

Diffusor in geblasenem Glas in glänzender Ausführung, in den Farben weiss oder amber und als mattierte version in gruen-grau oder in sandrot erhältlich. Struktur aus lackiertem Metall.

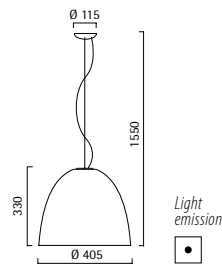

Difusores en vidrio soplado en los colores blanco brillante, ámbar brillante, gris - verde mate y arena - rojo mate. Estructura de metal cromado brillo.

Дутое стекло представлено в белом и песочном глянцевых цветах или в матовом зеленом и красном цветах, обработанных пескоструйным способом.



Lampada sospensione - *Pendant lamp*

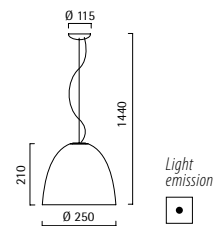

- 013756** Bianco - *White*
- 013757** Ambra - *Amber*
- 013754** Verde-Sabbia - *Sandy Green*
- 013755** Rosso-Sabbia - *Sandy Red*

E27 1x105W A55   
E27 1x24W TC-TSE 



Lampada sospensione - *Pendant lamp*

- 013752** Bianco - *White*
- 013753** Ambra - *Amber*
- 013750** Verde-Sabbia - *Sandy Green*
- 013751** Rosso-Sabbia - *Sandy Red*

E27 1x70W A55   
E27 1x21W TC-TSE 

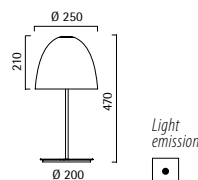
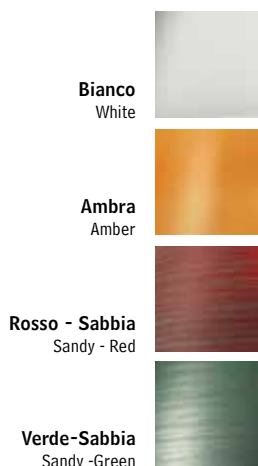

Lampada da tavolo - *Table lamp*

- 013760** Bianco - *White*
- 013761** Ambra - *Amber*
- 013758** Verde-Sabbia - *Sandy Green*
- 013759** Rosso-Sabbia - *Sandy Red*

E27 1x70W A55 

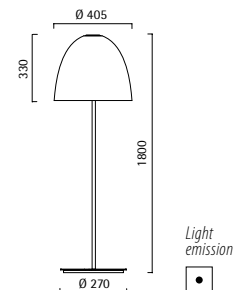

Lampada da terra - *Floor lamp*

- 013768** Bianco - *White*
- 013769** Ambra - *Amber*
- 013766** Verde-Sabbia - *Sandy Green*
- 013767** Rosso-Sabbia - *Sandy Red*

E27 1x105W A55 





DECO'











# BANALE

design Giandomenico Belotti, Carlo Forcolini 2001

**Diffusori in vetro soffiato opale satinato.  
Corpo tubolare in metallo cromato opaco.  
Meccanismo di inserimento e  
disinserimento di ciascuna sfera in  
termoplastico trasparente.**

Satin opal blown glass. Mat chrome metal body.  
Each sphere is inserted and extracted  
by means of clear thermoplastic gear.

Verre soufflé opale satiné.  
Corps tubulaire en métal chromé mat. Mécanisme  
de fixation et d'enlèvement de chaque glob en  
matériel thermoplastique transparent.

Satiniertem, geblasenem Opalglas. Röhrenstruktur  
aus matt verchromtem Metall. Aufsetz- und  
Abnehmmechanismus der einzelnen Kugeln aus  
transparentem thermoplastischen Material.

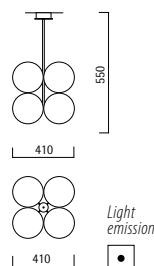

Difusores en vidrio soplado opal  
satinado. Cuerpo tubular en metal cromado opaco.  
Mecanismo de fijación de cada una  
de las bolas en termoplástico transparente.

Плафоны из дутого матового белого стекла.  
Ножка в матовом хроме.



Lampada da soffitto - *Ceiling lamp*  
Vetro satinato - *Satin glass*

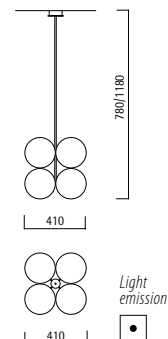

**013549**

E27 8x42W A55   
E27 8x14W TC-TSE 



Lampada sospensione - *Pendant lamp*  
Vetro satinato - *Satin glass*

**013170**

E27 8x42W A55   
E27 8x14W TC-TSE 



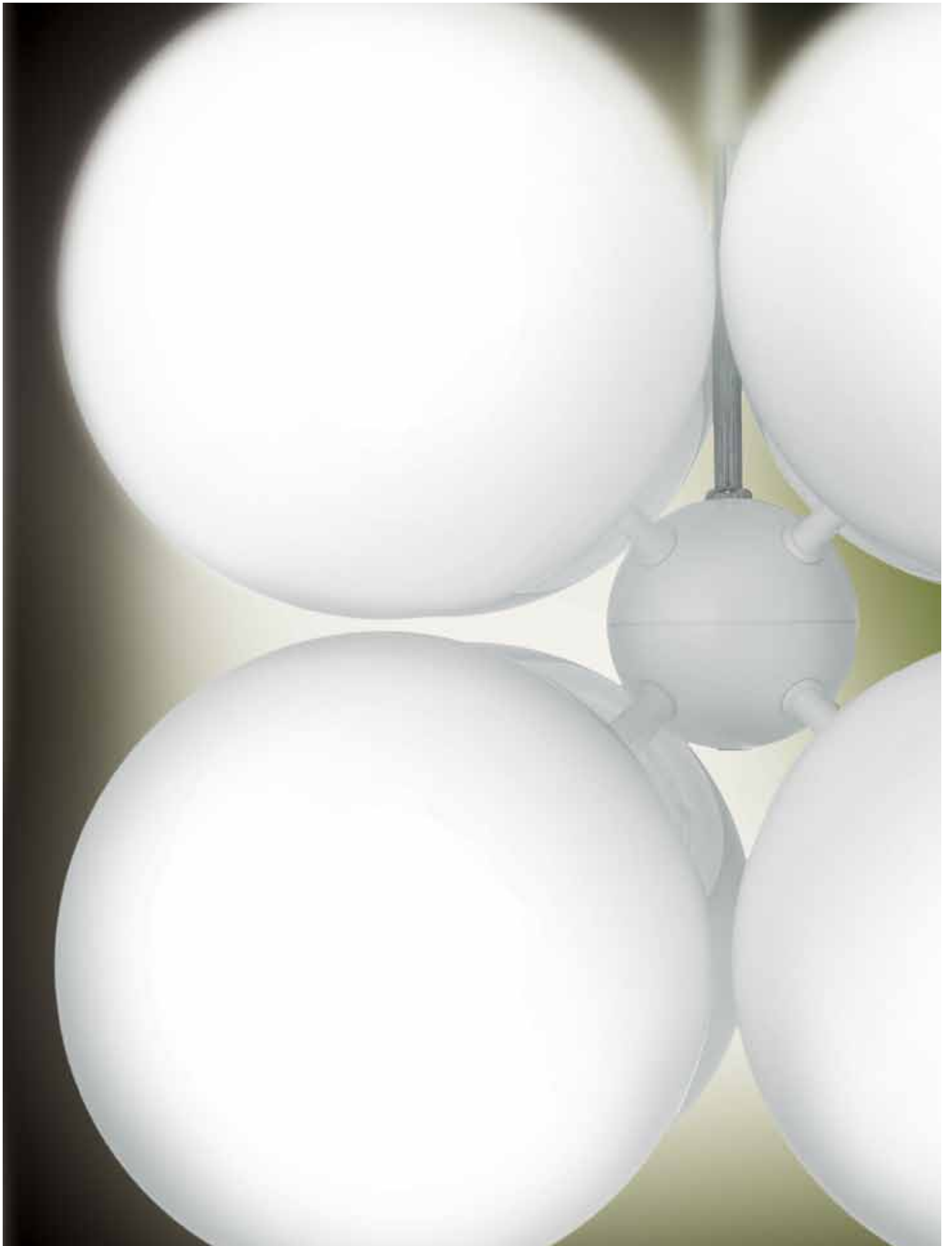

# BANALE

design Gandenico Belotti, Carlo Forcolini 2001







# BANALE

design Gandenico Belotti, Carlo Forcolini 2001





# NURA

design Lucente lab

**Serie di lampade in tessuto pongè plissettato tinta avorio. La struttura è in metallo cromato. Nura è disponibile nella versione a sospensione (singola oppure multipla), parete, tavolo e terra, entrambe dotate di varialuce.**

Range of lights in ivory pleated pongè fabric. Chrome metal structure. One-light and four-lights pendant, wall light, table and floor lamps both with dimmer.

Gamme de luminaire en tissu plissé pongé ivoire. Structure en métal chromé. Disponible en version suspension seule ou multiple, applique, lampe de table et lampe de terre qui sont disponibles avec variateur.

Leuchtenserie aus plissiertem elfenbeinfarbenem Pongé-Stoff. Die Struktur besteht aus verchromtem Metall. Nura ist als Hängeleuchte mit einem großen Diffusor oder vier kleinen Diffusoren, als Wand-, Tisch- oder Bodenleuchte erhältlich. Es können Energiesparlampen verwendet werden. Die Tisch- und Bodenversionen sind mit einem Dimmer ausgestattet.

Lámparas en tejido pongè plisado color marfil. Estructura en metal en acabado cromo. Nura es disponible en la versión suspendida a una luz o con más luces, en la versión de pared, sobremesa y de pie, las dos con atenuador.

Серия светильников с абажурами из плессированной ткани цвета слоновой кости. Корпус из хромированного металла. Светильник NURA может быть подвесным (с одним абажуром или несколькими), настенным, напольным или настольным. Последние два варианта диммируются.



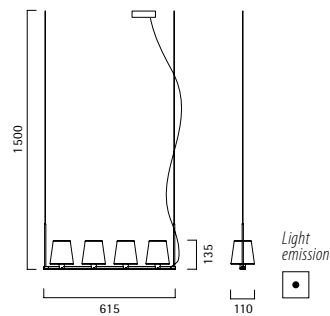

Lampada sospensione - *Pendant lamp*  
**004321** Pongè avorio - *Ivory pongè*  
 G9 4x33W QT-13

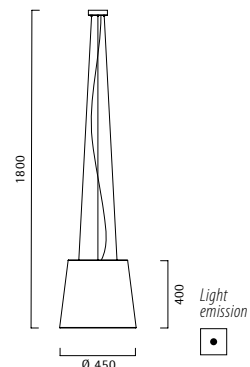

Lampada sospensione - *Pendant lamp*  
**004322** Pongè avorio - *Ivory pongè*  
 E27 2x105W A55  
 E27 2x100W QT-32  
 E27 2x21W TC-TSE

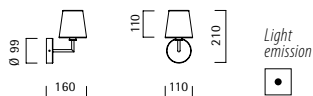

Lampada da parete - *Wall lamp*  
**004320** Pongè avorio - *Ivory pongè*  
 G9 1x48W QT-13

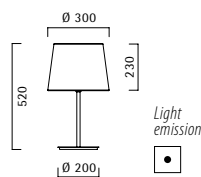

Lampada da tavolo - *Table lamp*  
**004323** Pongè avorio - *Ivory pongè*  
 E27 1x105W A55  
 E27 1x100W QT-32

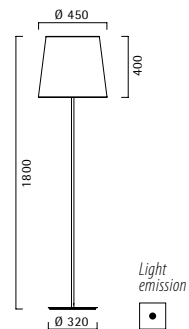

Lampada da terra - *Floor lamp*  
**004324** Pongè avorio - *Ivory pongè*  
 E27 2x105W A55  
 E27 2x100W QT-32



NURA











# NURA





# PROJECT 03

design Thomas Sandell 2005

**Struttura in alluminio pressofuso verniciato bianco. Sospensione con tige cromata regolabile in altezza. Diffusori in vetro soffiato opalino.**

White painted die-cast aluminium structure.  
Hanging lamp with height-adjustable chrome stem. Opal blown glass diffusers.

Lampes en aluminium moulé sous pression laqué blanc. Suspension avec tige réglable en hauteur, chromée. Diffuseurs en verre soufflé opalin.

Leuchtenserie aus Aluminiumdruckguss, weiß lackiert. Hängeleuchte, höhenverstellbar verchromt. Diffusoren aus geblasenem Glas.

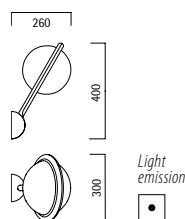

Estructura de aluminio vaciada a presión, barnizado en blanco. Colgante con asta cromada ajustable. Difusores de vidrio soplado opalino.

Окрашенное в белый цвет литое алюминиевое основание.  
Регулируемая по высоте ножка потолочного светильника.  
Рассеиватель из белого дутого стекла.



Lampada da parete - Wall lamp

**014021** Bianco - White

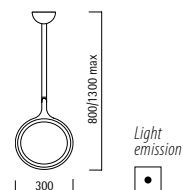

E27 1x70W QT-32   
E27 1x24W TC-TSE 

CE   



Lampada sospensione - Pendant lamp

**014020** Bianco - White

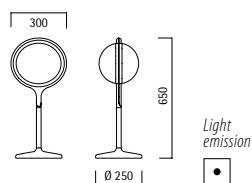

E27 1x70W QT-32   
E27 1x24W TC-TSE 

CE   



Lampada da tavolo - Table lamp

**014023** Bianco - White

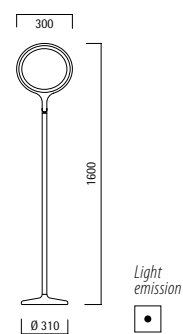

E27 1x70W QT-32   
E27 1x24W TC-TSE 

CE   



Lampada da terra - Floor lamp

**014022** Bianco - White

E27 1x70W QT-32   
E27 1x24W TC-TSE 

CE   

**Lampada sospensione telescopica**  
Height-adjustable pendant lamp







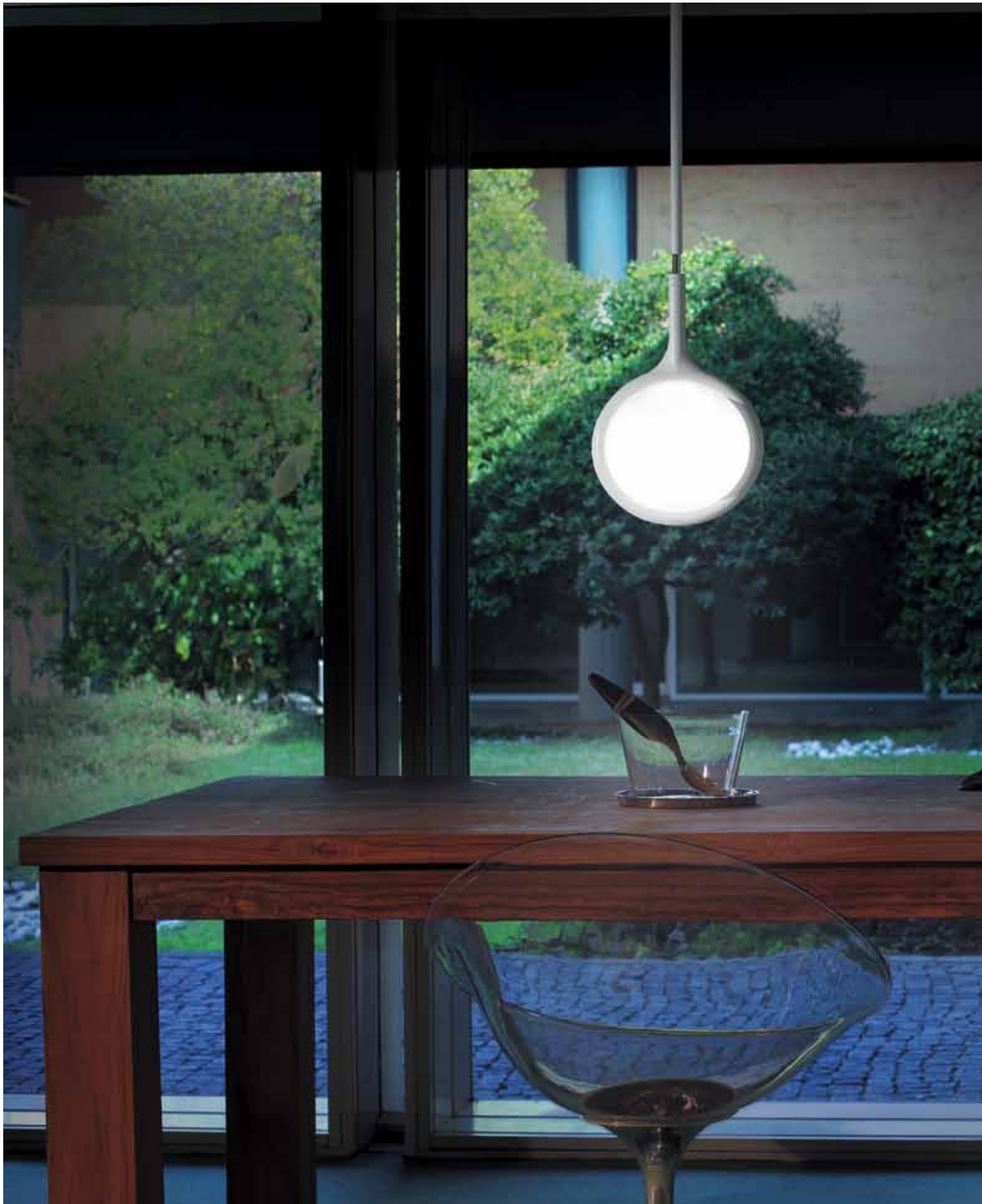

PROJECT 03  
design Thomas Sandell 2005





# PROJECT 03

design Thomas Sandell 2005





# NOA

design Lucente Lab

**Diffusore in vetro soffiato con finitura lucida, disponibile nei colori bianco, verde e arancio. Struttura in metallo bianco opaco.**

Blown glass diffuser available in glossy white, green and orange. Matt white metal structure.

Diffuseur en verre soufflé avec finition brillante, disponible en blanc, vert ou orange. Structure en métal blanc opaque.

Diffusor in geblasenem Glas in glänzender Ausführung, in den Farben weiss, grün und orange erhältlich. Struktur in weiss mattiertem Metall.

Difusores en vidrio soplado brillante disponible en los colores blanco, verde y anaranjado. Estructura metálica barnizada blanca.

Дутое стекло представлено в белом, зеленом и оранжевом глянцевых цветах. Металлическое основание матового белого цвета.



**Bianco**  
White



**Verde**  
Green



**Arancio**  
Orange





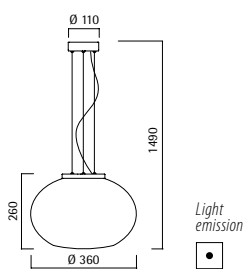

Lampada sospensione - Pendant lamp

- 009236** Bianco - White
- 009237** Arancio - Orange
- 009238** Verde - Green

E27 1x105W A55

E27 1x21W TC-TSE

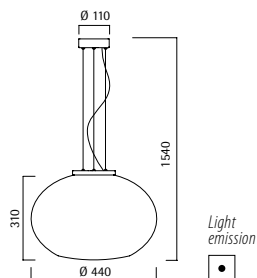

Lampada sospensione - Pendant lamp

- 009239** Bianco - White
- 009240** Arancio - Orange
- 009241** Verde - Green

E27 1x105W A55

E27 1x24W TC-TSE

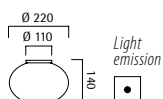

Lampada da soffitto/parete  
Ceiling/wall lamp

- 009251** Bianco - White
- 009252** Arancio - Orange
- 009253** Verde - Green

G9 1x33W QT-13

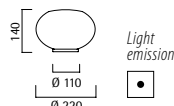

Lampada da tavolo - Table lamp

- 009242** Bianco - White
- 009243** Arancio - Orange
- 009244** Verde - Green

G9 1x48W QT-13

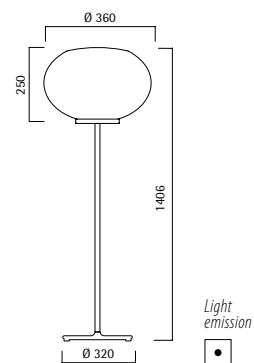

Lampada da terra - Floor lamp

- 009230** Bianco - White
- 009231** Arancio - Orange
- 009232** Verde - Green

E27 1x105W A55

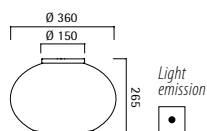

Lampada da soffitto/parete  
Ceiling/wall lamp

- 009254** Bianco - White
- 009255** Arancio - Orange
- 009256** Verde - Green

E27 1x105W A55

E27 1x21W TC-TSE

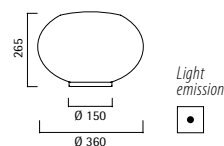

Lampada da tavolo - Table lamp

- 009245** Bianco - White
- 009246** Arancio - Orange
- 009247** Verde - Green

E27 1x105W A55

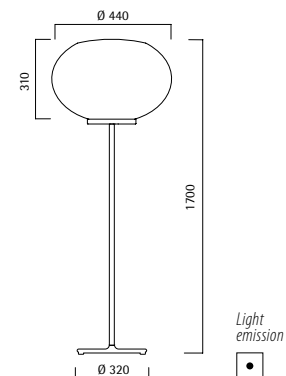

Lampada da terra - Floor lamp

- 009233** Bianco - White
- 009234** Arancio - Orange
- 009235** Verde - Green

E27 1x105W A55

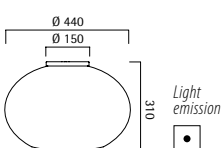

Lampada da soffitto/parete  
Ceiling/wall lamp

- 009257** Bianco - White
- 009258** Arancio - Orange
- 009259** Verde - Green

E27 1x105W A55

E27 1x24W TC-TSE

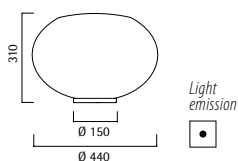

Lampada da tavolo - Table lamp

- 009248** Bianco - White
- 009249** Arancio - Orange
- 009250** Verde - Green

E27 1x105W A55

NOA



















**Struttura in metallo verniciato bianco,  
cromato o nickel spazzolato.  
Diffusore in PMMA satinato.  
Alimentazione elettronica.**

Metal structure available in white painted,  
chrome and brushed nickel.  
The PMMA acrylic diffuser is satin.  
Electronic ballast.

Structure en métal laqué blanc,  
chrome brillant et nickel brossé.  
Diffuseur en PMMA satiné.  
Ballast électronique.

Struktur aus Weiß, Verchromt,  
Nickel gebürstet Metal.  
PMMA diffuser.  
Elektronische Stromversorgung.





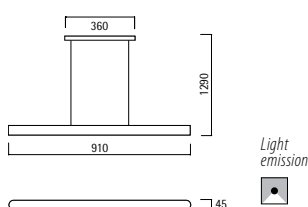

Estructura de metal cromado,  
níquel cepillado o blanco.  
Difusor en PMMA satinado.  
Alimentación electrónica.

Металлическое основание в никеле,  
хроме, черном и белом цветах.  
Матовый акриловый рассеиватель.  
Электронный балласт.

curve fotometriche disponibili photometrics available 







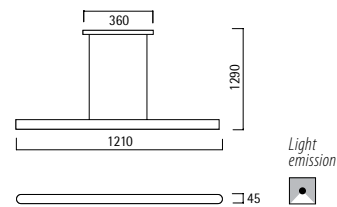

Lampada sospensione - *Pendant lamp*

**016050** Cromo - *Chrome*  
**016051** Nickel spazzolato - *Brushed nickel*  
**016053** Bianco - *White*  
G5 1x39W T5   
CE     







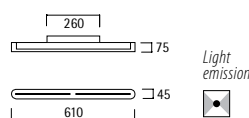
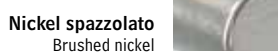

Lampada sospensione - *Pendant lamp*

**016054** Cromo - *Chrome*  
**016055** Nickel spazzolato - *Brushed nickel*  
**016057** Bianco - *White*  
G5 1x54W T5   
CE     







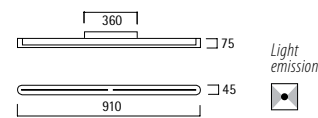

Lampada da parete - *Wall lamp*

**016040** Cromo - *Chrome*  
**016041** Nickel spazzolato - *Brushed nickel*  
**016043** Bianco - *White*  
G5 1x24W T5   
CE     



Lampada da parete - *Wall lamp*

**016044** Cromo - *Chrome*  
**016045** Nickel spazzolato - *Brushed nickel*  
**016047** Bianco - *White*  
G5 1x39W T5   
CE     



WAY

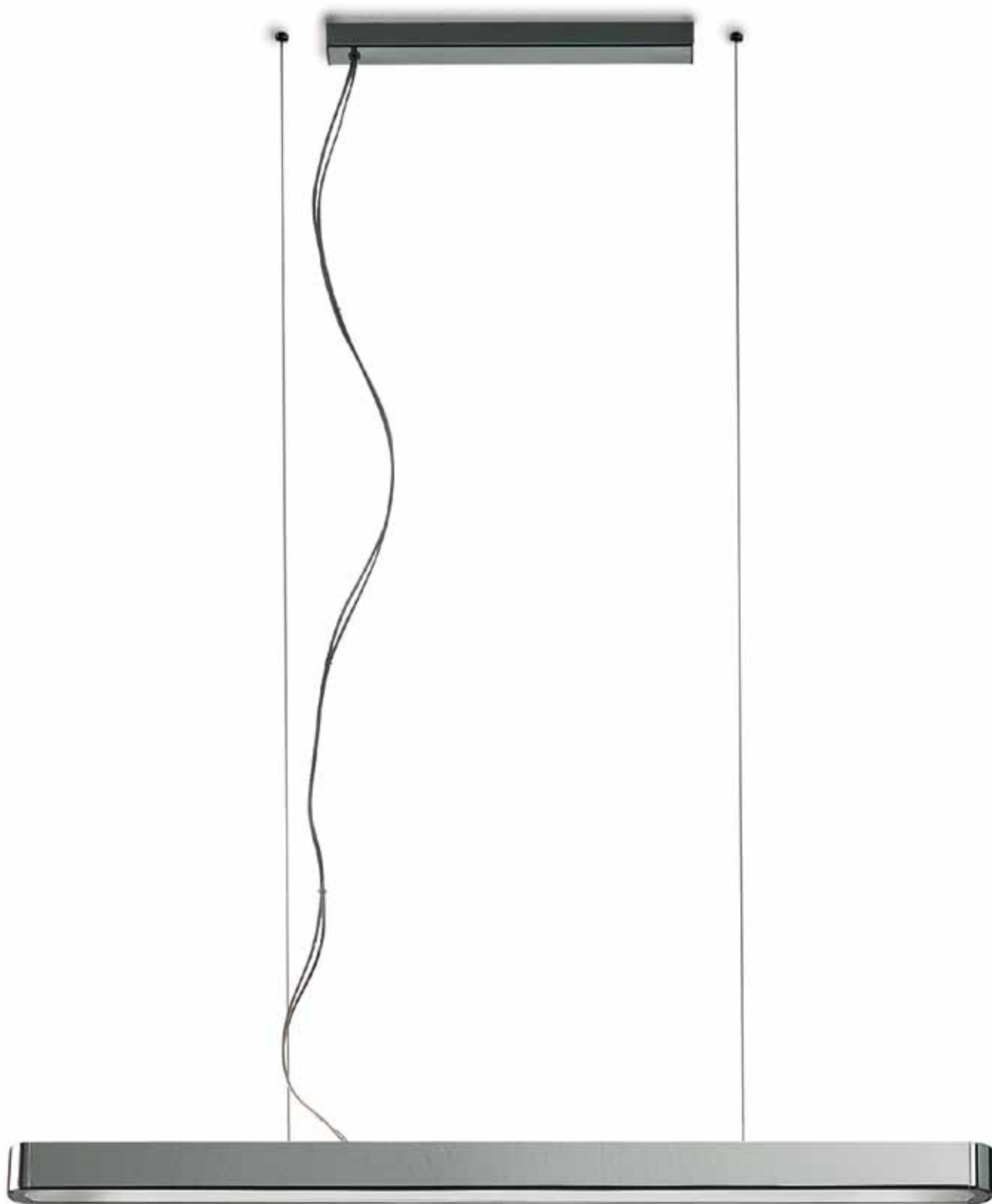





# STYLE

design Lucente Lab

**Serie di lampade in estruso di alluminio anodizzato, schermo diffusore estruso in policarbonato bianco opale 850°GW (glow wire). Finiture laterali delle sospensioni e delle lampade da parete in alluminio pressofuso cromato. Alimentazione elettronica.**

Extruded anodized aluminium lamps.  
Side chrome details on the wall and pendant lamps.  
White polycarbonate diffuser 850° GW.  
Electronic ballast.

Séries de lampes en aluminium extrudé anodisé, écran diffuseur en polycarbonate blanc opale 850° GW (glow wire). Finitions latérales des suspensions et des appliques en fonte d'aluminium aluminium chromée. Alimentation électronique.

Leuchten in einem Alu-Pressprofil eloxiert, Diffusor aus opalem weißem Polycarbonat 850°GW. Seitliche Teile der Abhängung und der Wandleuchten aus verchromten Alu-Pressprofilen. Inklusive elektronischem Vorschaltgerät.

Serie de Lámparas con estructura en extrusión de aluminio anodizado, difusor en policarbonato blanco. Laterales de las lamparas colgadas y lampara pared en aluminio cromado vaciado por presión. Alimentación electrónica.

Белый рассеиватель из поликарбоната.  
Электронный балласт.

curve fotometriche disponibili photometrics available 



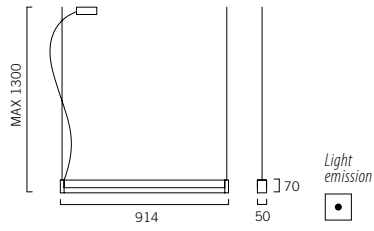

Lampada sospensione - *Pendant lamp*  
Alluminio anodizzato - *Anodized aluminium*

**013656**

G5 1x39W T5

CE

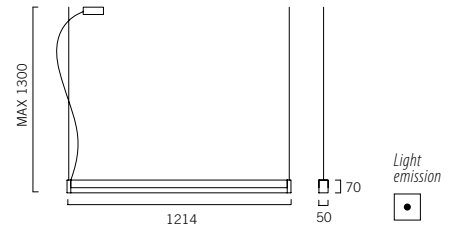

Lampada sospensione - *Pendant lamp*  
Alluminio anodizzato - *Anodized aluminium*

**013657**

G5 1x54W T5

CE

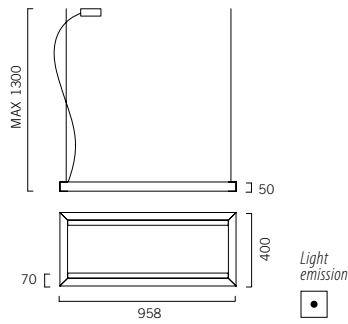

Lampada sospensione - *Pendant lamp*  
Alluminio anodizzato - *Anodized aluminium*

**013658**

G5 2x39W T5

CE

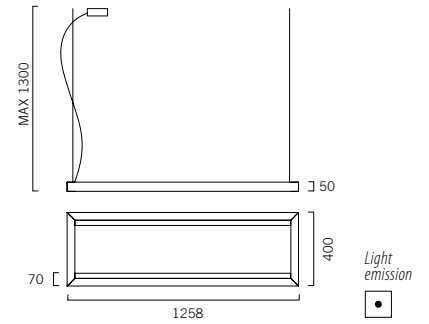

Lampada sospensione - *Pendant lamp*  
Alluminio anodizzato - *Anodized aluminium*

**013659**

G5 2x54W T5

CE

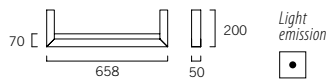

Lampada da parete/soffitto - *Wall/ceiling lamp*

**013650** Alluminio anodizzato - *Anodized aluminium*

G5 1x24W T5

CE

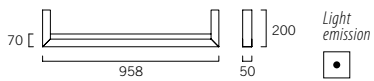

Lampada da parete/soffitto - *Wall/ceiling lamp*

**013651** Alluminio anodizzato - *Anodized aluminium*

G5 1x39W T5

CE



Lampada da parete/soffitto - *Wall/ceiling lamp*

**013652** Alluminio anodizzato - *Anodized aluminium*

G5 1x54W T5

CE

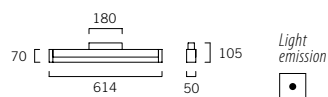

Lampada da parete/soffitto - *Wall/ceiling lamp*

**013653** Alluminio anodizzato - *Anodized aluminium*

G5 1x24W T5

CE

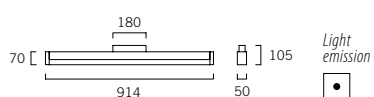

Lampada da parete/soffitto - *Wall/ceiling lamp*

**013654** Alluminio anodizzato - *Anodized aluminium*

G5 1x39W T5

CE

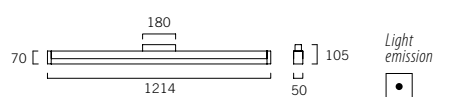

Lampada da parete/soffitto - *Wall/ceiling lamp*

**013655** Alluminio anodizzato - *Anodized aluminium*

G5 1x54W T5

CE

# STYLE



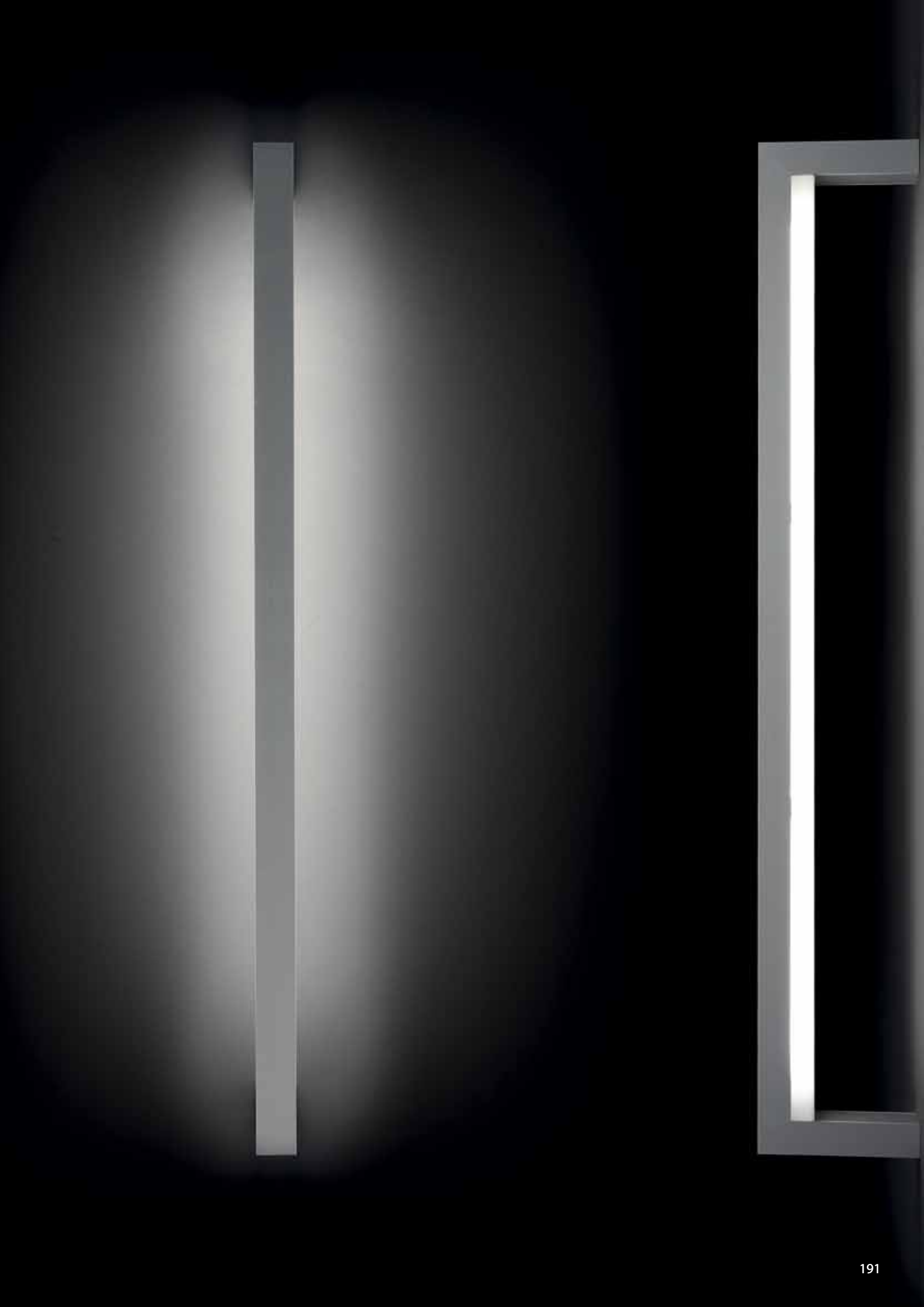

# CU-BIC IP44 design Lucente Lab

**Struttura in metallo verniciato bianco opaco oppure anodizzato spazzolato. Vetro di protezione serigrafato nero. Grado di protezione IP44 nelle versioni a parete. Solo per installazioni interne.**

Metal structure available in matt white and anodized brushed aluminium. Black painted glass. IP44 rated on the wall version. Only for indoor installation.

Structure en métal blanc opaque verni ou anodisé, verre de protection sérigraphie noir. Degré de protection IP 44 pour la version applique seulement. Seulement pour installation intérieure.



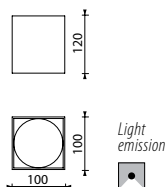

Struktur in weiss matt lackiertem oder eloxiertem mattem Metall. Das Schutzglas ist in schwarz. Bei der Wand-Version ist die Schutzart IP44. Nur für Installationen im Innenbereich gedacht.

Estructura metálica barnizada blanca o en aluminio anodizado cepillado. Vidrio serigrafiado negro. IP 44 en los modelos da pared. Adecuado solo para instalaciones interiores.

Металлическое основание в матовом белом и анодированном алюминии. Крашеное стекло черного цвета. IP 44. олько для внутреннего использования.





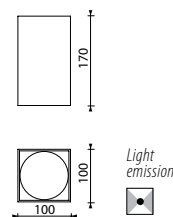

Lampada da parete - Wall lamp - IP 44

**016730** Bianco - White  
**016731** Alluminio - Aluminium  
 GU10 1x50W QPAR   
   





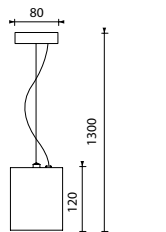

Lampada da parete - Wall lamp - IP 44

**016732** Bianco - White  
**016733** Alluminio - Aluminium  
 GU10 2x50W QPAR   
   



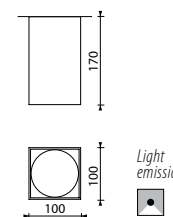

Lampada sospensione - Pendant lamp - IP 20

**016740** Bianco - White  
**016741** Alluminio - Aluminium  
 GU10 1x75W QPAR   
   



Lampada da soffitto - Ceiling lamp - IP 20

**016736** Bianco - White  
**016737** Alluminio - Aluminium  
 GU10 1x75W QPAR   
   



**Alluminio anodizzato spazzolato**  
 Anodized brushed aluminium









**Serie di lampade da parete a luce indiretta a bi emissione con struttura in metallo. La parte frontale è realizzata in diverse finiture: effetto legno wenge, effetto noce nazionale, verniciato bianco opaco, verniciato effetto cor-ten e verniciato grigio. Alimentazione elettronica.**

Metal wall lamps with indirect double emission light. The front is available in the finishes wenge-like, walnut-like, matt white painted, cor-ten-like painted and aluminium painted. Electronic ballast.

Applique en métal avec une lumière indirecte up and down. Disponible en effet wengé, effet noyé, blanc mat, gris brillant et effet cor-ten. Ballast électronique.

Wandleuchten-Serie aus Metall mit indirektem Licht und zweifacher Lichtemission. Die Front besteht aus verschiedenen Oberflächen: Wenge-Holz-Effekt, Nussholz-Effekt, mattweiße Lackierung, Cor-Ten-Stahleffekt und graue Lackierung. Elektronische Stromversorgung.

Lámpara de pared a luz indirecta biemission. Estructura en metal en los acabados: efecto wengué, efecto nogal, barnizado blanco mate, barnizado gris, barnizado efecto cor-ten. Ballast electrónico.

Серия настенных светильников, создающая эффект отраженного света с двусторонней эмиссией света. Металлический корпус снаружи может иметь следующие варианты окрасок: белый матовый, серый, с эффектом кортеповской стали, под дерево венге или орех. Электронный балласт.

curve fotometriche disponibili photometrics available 



### River LED

Lampada da parete - Wall lamp

- 007490** Effetto legno wenge - *Wenge like*
- 007491** Effetto legno noce nazionale - *Walnut like*
- 007492** Verniciato effetto cor-ten - *Cor-ten like painted*
- 007493** Bianco opaco - *Matt white*
- 007494** Grigio argento - *Silver grey*

LED 21W 3.000K°



Lampada da parete - Wall lamp

- 007390** Effetto legno wenge - *Wenge like*
- 007391** Effetto legno noce nazionale - *Walnut like*
- 007392** Verniciato effetto cor-ten - *Cor-ten like painted*
- 007393** Bianco opaco - *Matt white*
- 007394** Grigio argento - *Silver grey*

G5 2x24W T5 

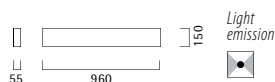

### River LED

Lampada da parete - Wall lamp

- 007485** Effetto legno wenge - *Wenge like*
- 007486** Effetto legno noce nazionale - *Walnut like*
- 007487** Verniciato effetto cor-ten - *Cor-ten like painted*
- 007488** Bianco opaco - *Matt white*
- 007489** Grigio argento - *Silver grey*

LED 32,5W 3.000K°



Lampada da parete - Wall lamp

- 007385** Effetto legno wenge - *Wenge like*
- 007386** Effetto legno noce nazionale - *Walnut like*
- 007387** Verniciato effetto cor-ten - *Cor-ten like painted*
- 007388** Bianco opaco - *Matt white*
- 007389** Grigio argento - *Silver grey*

G5 2x39W T5 

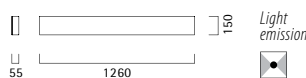

### River LED

Lampada da parete - Wall lamp

- 007480** Effetto legno wenge - *Wenge like*
- 007481** Effetto legno noce nazionale - *Walnut like*
- 007482** Verniciato effetto cor-ten - *Cor-ten like painted*
- 007483** Bianco opaco - *Matt white*
- 007484** Grigio argento - *Silver grey*

LED 44W 3.000K°



Lampada da parete - Wall lamp

- 007380** Effetto legno wenge - *Wenge like*
- 007381** Effetto legno noce nazionale - *Walnut like*
- 007382** Verniciato effetto cor-ten - *Cor-ten like painted*
- 007383** Bianco opaco - *Matt white*
- 007384** Grigio argento - *Silver grey*

G5 2x54W T5 



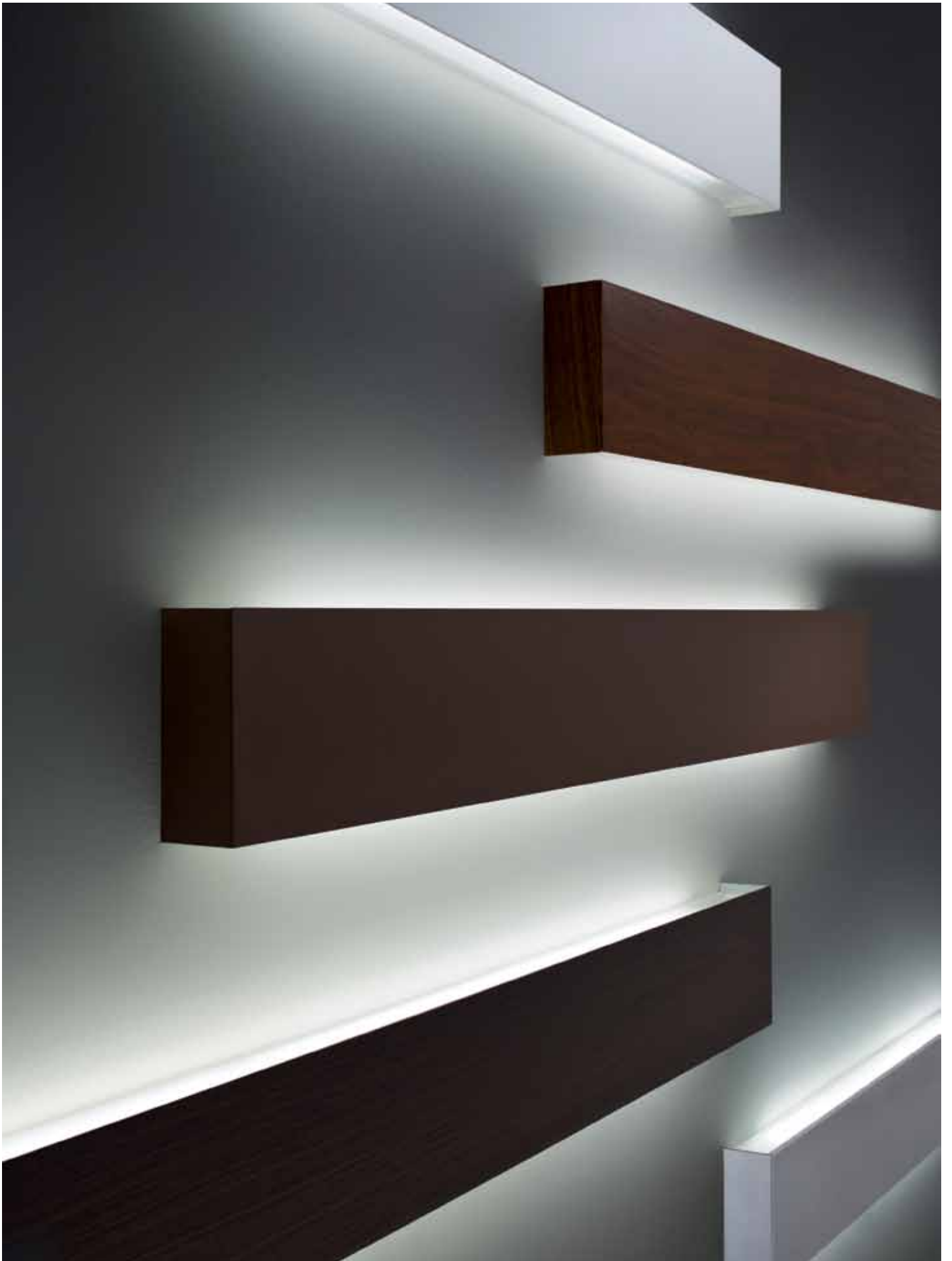





RIVER + RIVER LED







# TARA

design Lucente Lab

**Lampada da parete o soffitto a luce diffusa e indiretta, caratterizzata da una cornice quadrata in metallo disponibile in varie finiture: effetto legno wenge con striature argentate, foglia oro, foglia argento. Il diffusore inferiore e superiore è in PMMA opale. Alimentazione elettronica.**

Diffused indirect wall or ceiling light. Metal square frame available in the finishes wenge-like with silver stripes, gold leaf and silver leaf. Front and back PMMA matt diffusers. Electronic ballast.

Applique ou plafonnier, structure en métal disponible en différentes finitions : effet wengé, feuille d'or et feuille d'argent. Diffuseur inférieur et supérieur en PMMA opale. Ballast électronique.

Wandleuchte oder Deckenleuchte mit diffusem indirektem Licht. Unterer und oberer Diffusor (vorne) bestehen aus PMMA (Polymethylacrylat) opal. Oberfläche: Wenge-Holz-Effekt mit Silberstreifen, Blattgold, Blattsilber. Elektronische Stromversorgung.

Lámpara de pared y de techo a luz indirecta, marco cuadrado en metal en los acabados: efecto wengué con estriaciones color plata, plata en hojas, oro en hojas. Difusores en PMMA mate. Ballast electrónico.

Настенный или потолочный светильник, создающий неяркий и рассеянный свет.

Металлическая рамка (корпус) может иметь следующие отделки: золотой лист, серебряный лист, цвет венге с металлизированными прожилками.

Матовые акриловые рассеиватели. Имеется встроенный электронный балласт.

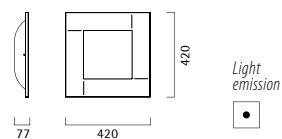

Lampada da parete/soffitto - Wall/ceiling lamp

**007320** Effetto legno wenge - Wenge like

**007321** Foglia argento - Silver leaf

**007322** Foglia oro - Gold leaf

2GX13 1x22W T5c

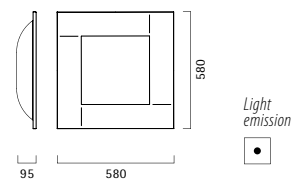

Lampada da parete/soffitto - Wall/ceiling lamp

**007323** Effetto legno wenge - Wenge like

**007324** Foglia argento - Silver leaf

**007325** Foglia oro - Gold leaf

2GX13 40+22W T5c



**Effetto legno wenge**  
Wenge like



**Foglia argento**  
Silver leaf



**Foglia oro**  
Gold leaf







TARA







# SAO

design Lucente Lab

**Lampada da parete o soffitto con diffusore inferiore e superiore in PMMA opale. Finiture cromate. Struttura interna in metallo verniciata bianca. Alimentazione elettronica.**

Wall and ceiling lamp with opal PMMA top and bottom diffusers. Chrome details. White painted inside metal frame. Electronic ballast.

Applique ou plafonnier avec diffuseur inférieur et supérieur en PMMA opale. Finitions chromées. Structure interne en métal verni blanc. Alimentation électronique.

Verchromte Wand – oder Deckenleuchte mit einem oberen und unteren Diffusor aus opalem PMMA. Innere Struktur in weiß lackiertem Metall inklusive elektronischem Vorschaltgerät.

Lampara de pared o techo con difusor inferior y superior en PMMA opalo. Acabado Cromo. Estructura interna en metal barnizado Blanco. Iluminación electronica.

Настенные и потолочные светильники с рассеивателем из поликарбоната. Электронный балласт.

curve fotometriche disponibili photometrics available 

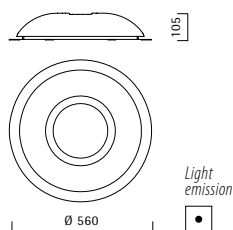

Lampada da parete/soffitto - Wall/ceiling lamp

**015306** Cromo - Chrome

2GX13 40+22W T5c 

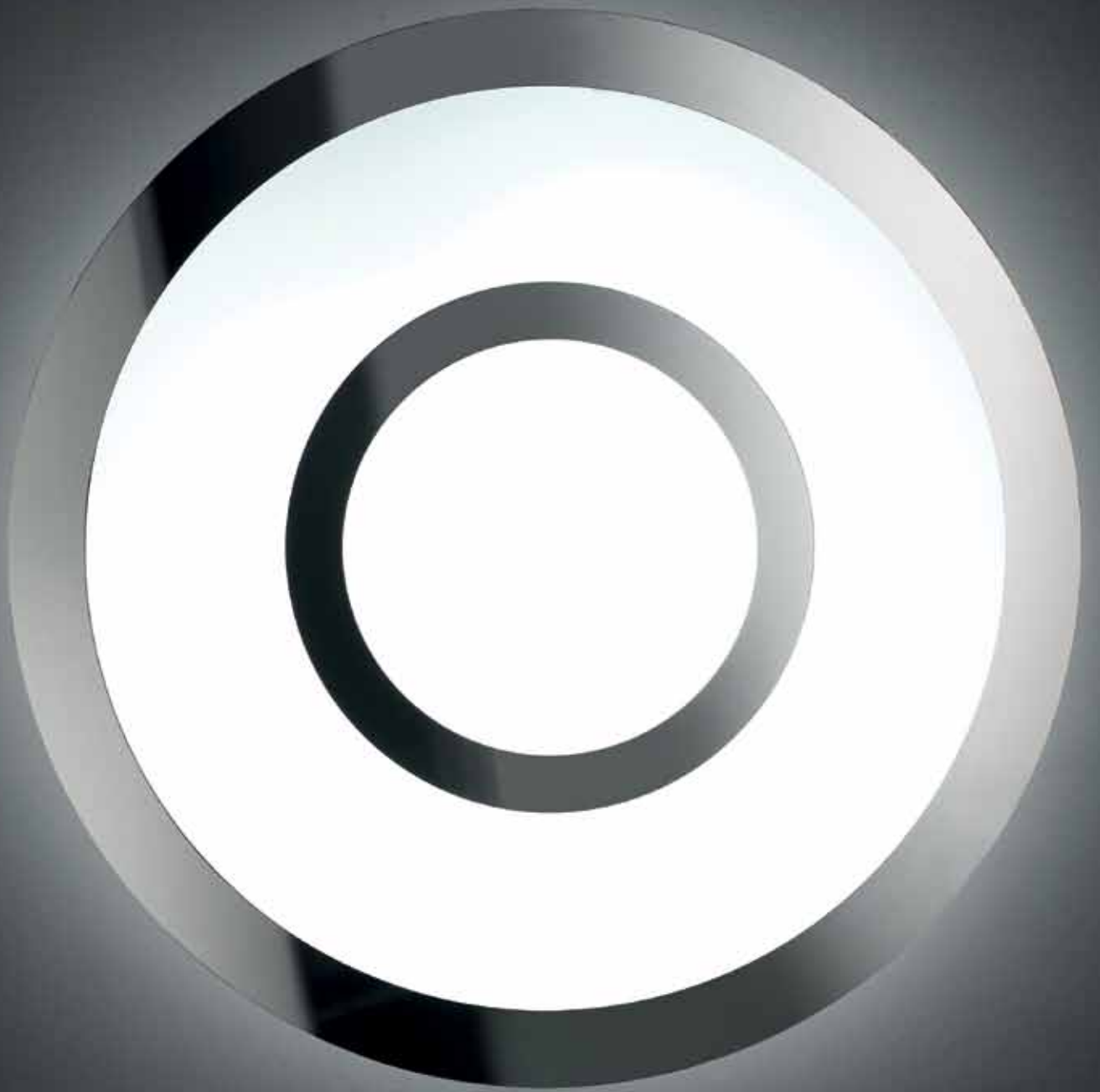

# EIGHT

design Sandro Santantonio Design 2009

**Struttura in metallo disponibile nei colori bianco opaco, verniciato rame oppure cromo lucido. Diffusore inferiore e superiore in PMMA opale. Nella versione Ø 200 diffusore inferiore e superiore in vetro.**

Metal structure available in matt white, copper painted and glossy chrome. Opal PMMA diffusers. Glass diffusers only for the Ø 200.

Structure en métal disponible en blanc opaque, cuivre verni ou chrome lustré. Diffuseur inférieur et supérieur en PMMA opale. Dans la version Ø 200 diffuseur inférieur et supérieur en verre.

Metalstruktur erhältlich in den Farben weiss matt, kupfer lackiert oder in chrom glänzend. Der Diffusor in PMMA opal. Den Glas-Diffusor gibt es nur in der Version Ø 200.

Estructura metálica barnizada blanca mate, cobre o en cromo brillo. Difusores inferior y superior de PMMA opalino. Por el modelo Ø 200 difusores de vidrio.

Металлическое основание может быть в матовом белом, крашенном медном или хромированном цветах. Рассеиватель из метакрилата. Так же возможен вариант рассеивателя из стекла для светильника f 200.

curve fotometriche disponibili photometrics available 

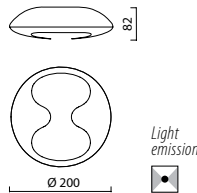

Lampada da parete/soffitto - Wall/ceiling lamp

**008862** Bianco - White  
**008860** Cromo - Chrome  
**008861** Rame - Copper

G9 2x20W QT-13 

**008865** Bianco - White  
**008863** Cromo - Chrome  
**008864** Rame - Copper

GX53 1x9W 

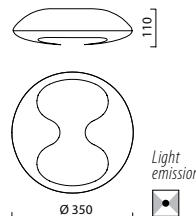

Lampada da parete/soffitto - Wall/ceiling lamp

**008878** Bianco - White  
**008876** Cromo - Chrome  
**008877** Rame - Copper

E27 2x21W TC-TSE 

**008872** Bianco - White  
**008870** Cromo - Chrome  
**008871** Rame - Copper

G24q-2 2x18W TC-DE   
Alimentazione elettronica - Electronic ballast

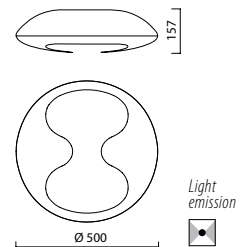

Lampada da parete/soffitto - Wall/ceiling lamp

**008891** Bianco - White  
**008889** Cromo - Chrome  
**008890** Rame - Copper

E27 2x24W TC-TSE 

**008888** Bianco - White  
**008886** Cromo - Chrome  
**008887** Rame - Copper

G24q-3 2x26W TC-DE   
Alimentazione elettronica - Electronic ballast

**008882** Bianco - White  
**008880** Cromo - Chrome  
**008881** Rame - Copper

2GX13 40+22W T5c   
Alimentazione elettronica - Electronic ballast

**008885** Bianco - White  
**008883** Cromo - Chrome  
**008884** Rame - Copper

GR10q 1x38W TC-DDE   
Alimentazione elettronica - Electronic ballast

   





# EIGHT

design Sandro Santantonio Design 2009

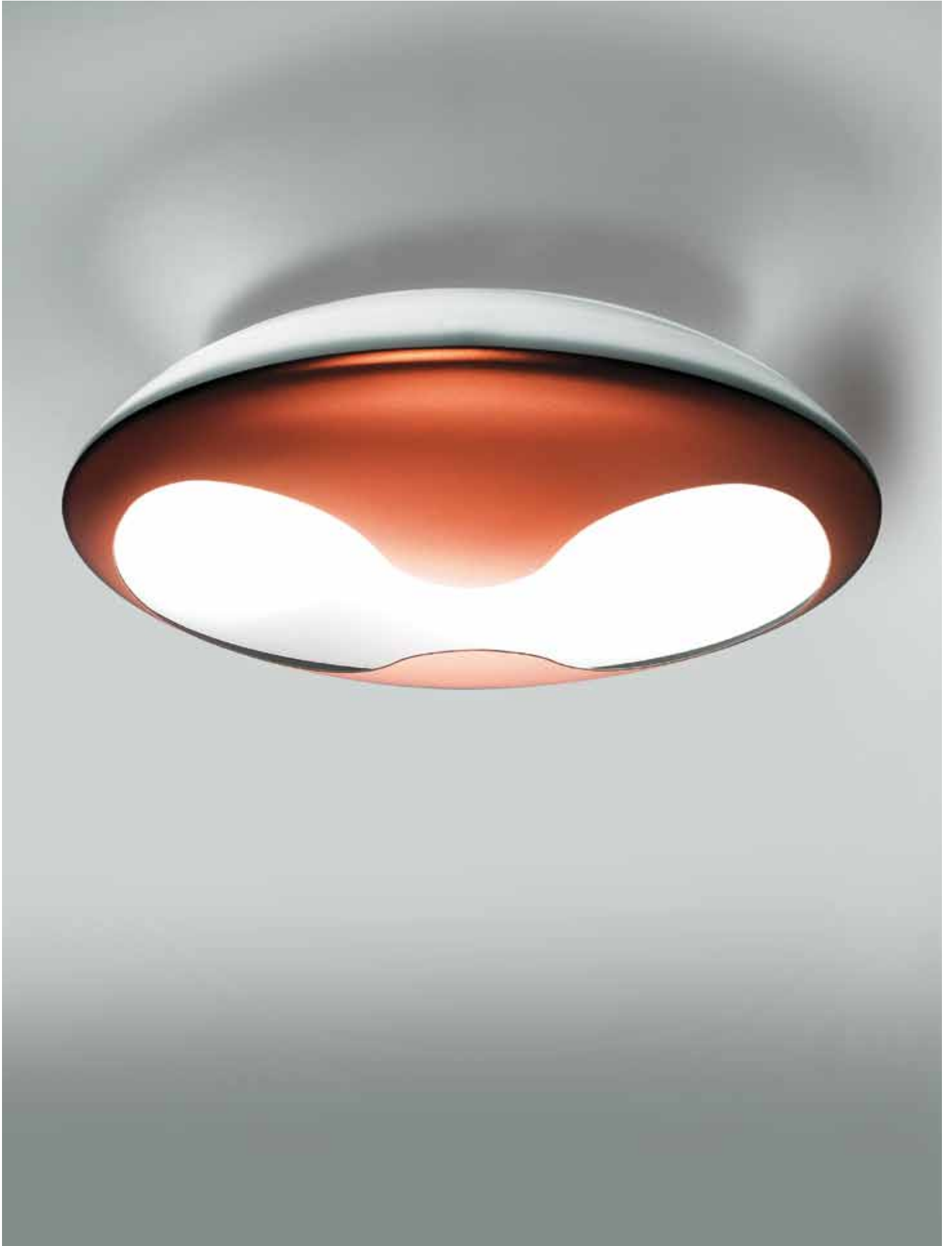



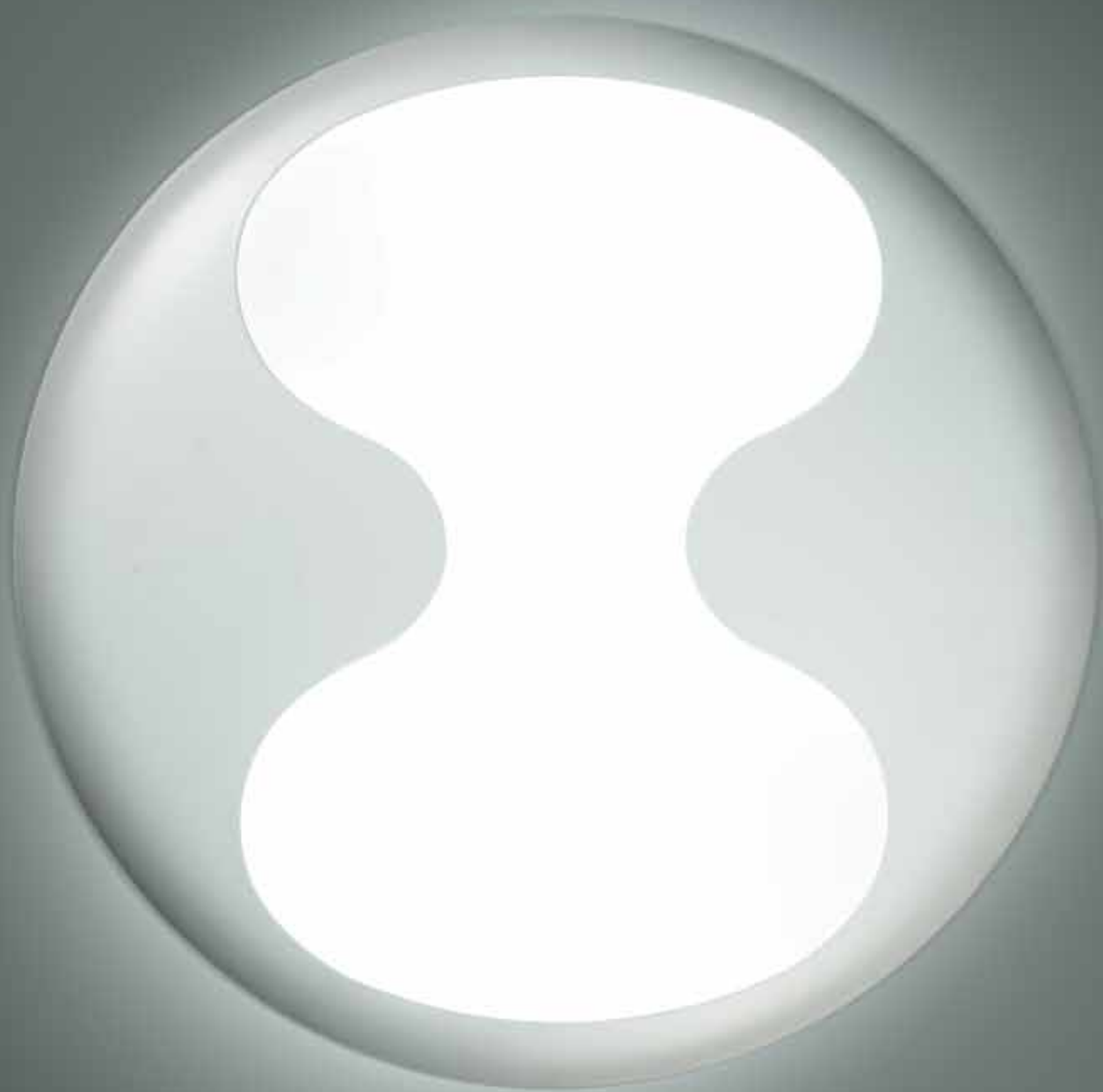

# ECLIPSE

design Dodo Arslan 2006

Riflettore in metallo verniciato nei  
colori grigio antracite o bianco.  
Diffusore in vetro soffiato.

Metal painted reflector in grey or white.  
Satin blown opal glass.

Spot frontal en métal verni disponible dans  
les couleurs gris ou blanc.  
Diffuseur en verre soufflé satiné opale.

Metal Reflektoren, weiß oder grau lackiert.  
Diffusoren aus geblasenem satinierte Glas.

Reflector de metal barnizado gris o blanco.  
Difusor de vidrio soplado opal satinado.

Металлический отражатель серого или белого  
цветов Матовое белое дутое стекло.

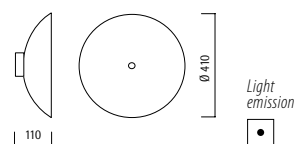

Lampada da soffitto/parete - *Ceiling/wall lamp*

**017280** Bianco - *White*

**017281** Grigio - *Grey*

2GX13 1x55W T5c 

alimentazione elettronica - *electronic ballast*

   

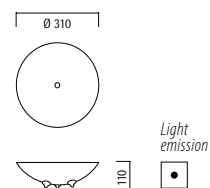



Lampada da tavolo - *Table lamp*

**017284** Bianco - *White*

**017285** Grigio - *Grey*

GX53 1x7W 





**ECLIPSE**  
design Dodo Arslan 2006



# PINKO

design Simone Deraì 2007

**Struttura in nickel spazzolato,  
diffusori in vetro stampato colorato:  
rosso, bianco, ambra trasparente  
e azzurro trasparente.**

Brushed nickel metal structure.  
Pressed glass diffusers available  
in white, red, clear amber and  
clear light blue.

Structure métallique nickel brossée.  
Diffuseur en verre dans les coloris:  
rouge, blanc, ambre transparent  
et bleu transparent.

Struktur aus Nickel gebürstet Metall.  
Lichtverteiler aus Glas in den Farben:  
Rot, Weiß, transparentem Opal,  
transparentem Bernstein.

Estructura en metal níquel cepillado.  
Difusor en vidrio en los colores:  
blanco, rojo, cobalto transparente,  
àmbar transparente.

Никелированное металлическое основание.  
Плафоны из стекла белого, красного,  
прозрачно-песочного или  
прозрачно-голубого цветов.

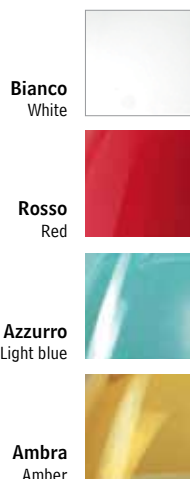



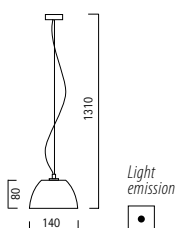

Lampada sospensione - Pendant lamp

- 013714** Bianco - White
- 013715** Rosso - Red
- 013716** Azzurro - Light blue
- 013717** Ambra - Amber

G9 1x48W QT-13

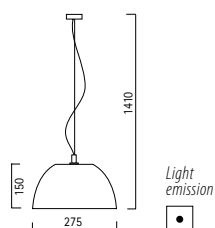

Lampada sospensione - Pendant lamp

- 013710** Bianco - White
- 013711** Rosso - Red
- 013712** Azzurro - Light blue
- 013713** Ambra - Amber

E27 1x52W A55

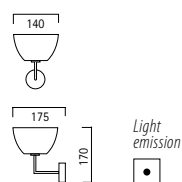

Lampada da parete - Wall lamp

- 013720** Bianco - White
- 013721** Rosso - Red
- 013722** Azzurro - Light blue
- 013723** Ambra - Amber

G9 1x48W QT-13

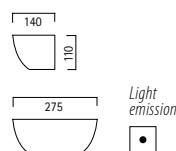

Lampada da parete - Wall lamp

- 013724** Bianco - White
- 013725** Rosso - Red
- 013726** Azzurro - Light blue
- 013727** Ambra - Amber

R7s 78mm 1x80W QT-DE

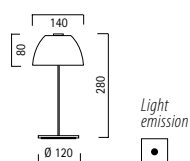

Lampada da tavolo - Table lamp

- 013734** Bianco - White
- 013735** Rosso - Red
- 013736** Azzurro - Light blue
- 013737** Ambra - Amber

G9 1x48W QT-13

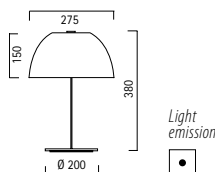
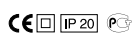

Lampada da tavolo - Table lamp

- 013730** Bianco - White
- 013731** Rosso - Red
- 013732** Azzurro - Light blue
- 013733** Ambra - Amber

E27 1x52W A55

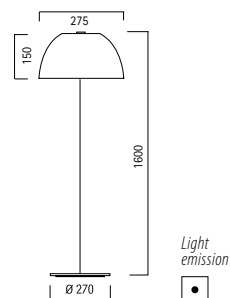
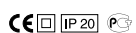

Lampada da terra - Floor lamp

- 013740** Bianco - White
- 013741** Rosso - Red
- 013742** Azzurro - Light blue
- 013743** Ambra - Amber

E27 1x52W A55

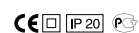



PINKO

design Simone Deraï 2007



PINKO

design Simone Derrai 2007





# REMEMBER

design Alessandro Mendini by Cleto Munari 2007

**Steli in metallo verniciato grigio,  
diffusori in tessuto bianco  
avorio, grigio, arancio.**

Grey painted metal structure.  
Fabric shades available in  
ivory-white, grey and orange.

Tiges en métal laqué gris,  
diffuseurs en tissu dans les coloris:  
blanc ivoire, gris, orange.

Graulackiertem Metallständer,  
Streukörper aus Stoff in den Farben:  
Elfenbeinweiß, Grau, Orange.

Estructura de metal pintado de gris,  
difusores de tela en varios colores:  
blanco marfil, gris, anaranjado.

Тканевый плафон представлен в цвете  
слоновой кости, сером или оранжевом цветах.  
Серое металлическое основание.

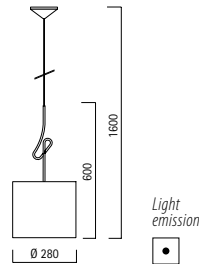

Lampada sospensione - *Pendant lamp*

**015823** Avorio - *Ivory*  
**015824** Grigio - *Grey*  
**015825** Arancio - *Orange*  
E27 1x70W A55   
CE

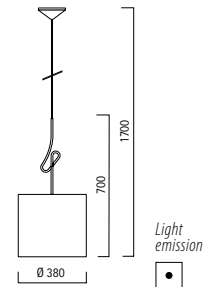

Lampada sospensione - *Pendant lamp*

**015820** Avorio - *Ivory*  
**015821** Grigio - *Grey*  
**015822** Arancio - *Orange*  
E27 1x70W A55   
CE

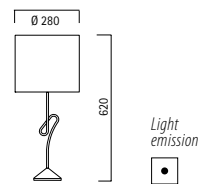

Lampada da tavolo - *Table lamp*

**015830** Avorio - *Ivory*  
**015831** Grigio - *Grey*  
**015832** Arancio - *Orange*  
E27 1x70W A55   
CE

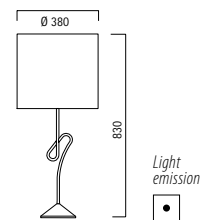

Lampada da tavolo - *Table lamp*

**015833** Avorio - *Ivory*  
**015834** Grigio - *Grey*  
**015835** Arancio - *Orange*  
E27 1x70W A55   
CE

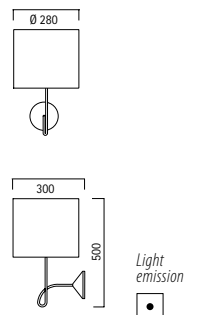

Lampada da parete - *Wall lamp*

**015826** Avorio - *Ivory*  
**015827** Grigio - *Grey*  
**015828** Arancio - *Orange*  
E27 1x70W A55   
CE

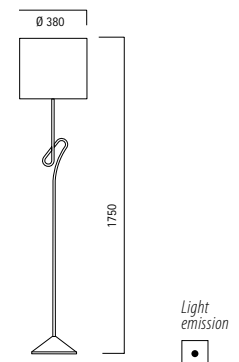

Lampada da terra - *Floor lamp*

**015836** Avorio - *Ivory*  
**015837** Grigio - *Grey*  
**015838** Arancio - *Orange*  
E27 1x70W A55   
CE









# REMEMBER

design Alessandro Mendini by Cleto Munari 2007



# REMEMBER

design Alessandro Mendini by Cleto Munari 2007





# SPOOL

design Mårten Claesson, Eero Koivisto, Ola Rune 2005

**Riflettori in alluminio verniciato bianco o grigio argento. Filtri colorati in metacrilato: rosso porpora, verde acido e blu cobalto. Sospensione dotata di vetro diffusore satinato.**

Reflectors in white or silver grey coated aluminium. Coloured methacrylate filters in purple red, acid green and cobalt blue. The pendant includes a satin glass diffuser in the base.

Réfecteurs en aluminium laqué blanc ou gris. Filtres colorés en méthacrylate rouge pourpre, vert acide et bleu cobalt. La suspension est réalisée avec un verre diffusant satiné.

Aluminiumreflektoren, weiß oder grau lackiert. Farbfilter aus Metacrylat in den Farben Purpurrot, Essiggrün und Kobaltblau. Die Hängeleuchte verfügt über einen satinierten Diffusor aus Glas.

Reflectores de aluminio barnizado blanco o gris. Filtros de metacrilato de color rojo púrpura, verde ácido y azul cobalto. El colgante está equipado con un vidrio difusor satinado.

Алюминиевые плафоны могут быть белого или темно-серого цветов. Фильтры из метакрилата представлены в красном, зеленом или синем цветах. Подвесной светильник поставляется с матовым диском из стекла. Включается легким прикосновением.



**Grigio argento**  
Silver grey



**Bianco**  
White





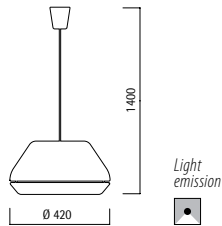

Lampada sospensione - *Pendant lamp*

**013807** Bianco - *White*  
**013808** Grigio argento - *Silver grey*  
 E27 1x100W QT-32   
 CE

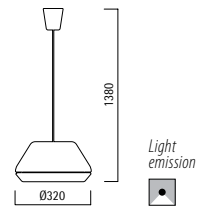

Lampada sospensione - *Pendant lamp*

**013806** Bianco - *White*  
**013804** Grigio argento - *Silver grey*  
 E27 1x100W QT-32   
 CE

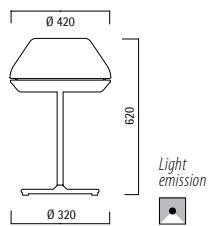

Lampada da tavolo - *Table lamp*

**013803** Bianco - *White*  
**013800** Grigio argento - *Silver grey*  
 E27 1x100W QT-32   
 CE

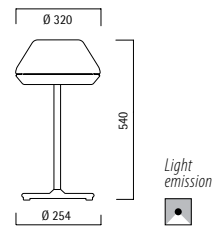

Lampada da tavolo - *Table lamp*

**013801** Bianco - *White*  
**013802** Grigio argento - *Silver grey*  
 E27 1x100W QT-32   
 CE

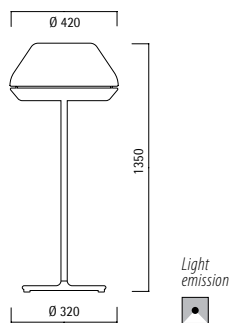

Lampada da terra - *Floor lamp*

**013805** Bianco - *White*  
**013809** Grigio argento - *Silver grey*  
 E27 1x100W QT-32   
 CE



Variatore a comando sensoriale  
*Touch dimmable*

- 060041** Verde - *Green* Ø 320
- 060042** Verde - *Green* Ø 420
- 060037** Blu - *Blue* Ø 320
- 060038** Blu - *Blue* Ø 420
- 060039** Rosso - *Red* Ø 320
- 060040** Rosso - *Red* Ø 420



# SPOOL

design Mårten Claesson, Eero Koivisto, Ola Rune 2005





# SPOOL

design Mårten Claesson, Eero Koivisto, Ola Rune 2005





**Serie da parete e sospensione.**  
**Struttura in estruso di alluminio**  
**anodizzato e metallo microforato cromato.**  
**Vetro di protezione in pirex satinato.**

Wall lamps and pendants.  
 Structure in extruded anodized aluminium  
 and chrome microperforated metal.  
 Satin pyrex seat protection glass.

Applique et suspension.  
 Structure en extrudé d'aluminium anodisé  
 et métal microperforé chromé.  
 Verre de protection en pyrex satiné.

Wandleuchte und Hängeleuchte  
 Struktur aus eloxiertem  
 stranggepresstem Aluminium und  
 verchromtem Siebblech. Schutzglas  
 aus satiniertem Pirex.

Lámpara de pared y suspensión.  
 Estructura en extruido de aluminio anodizado  
 y metal microperforado cromado.  
 Vidrio de protección en pirex satinado.

Корпус выполнен из штампованного  
 анодированного алюминия.  
 Перфорированные декоративные вставки.  
 Рассеиватели из жаростойкого стекла.

curve fotometriche disponibili photometrics available 

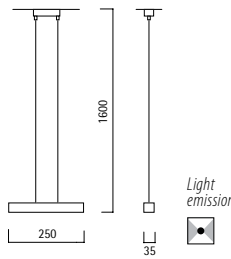

Lampada sospensione - *Pendant lamp*  
 Alluminio anodizzato - *Anodized aluminium*

**000101**

R7s 78mm 1x120W QT-DE 

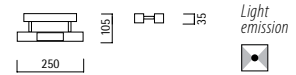

Lampada da parete - *Wall lamp*  
 Alluminio anodizzato - *Anodized aluminium*

**000102**

R7s 78mm 1x120W QT-DE 

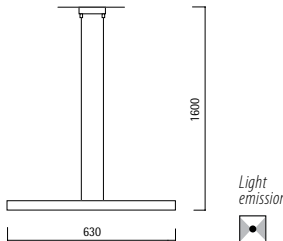

Lampada sospensione - *Pendant lamp*  
 Alluminio anodizzato - *Anodized aluminium*

**000100**

R7s 78mm 2x120W QT-DE 

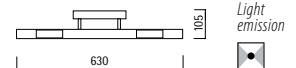

Lampada da parete - *Wall lamp*  
 Alluminio anodizzato - *Anodized aluminium*

**000103**

R7s 78mm 2x120W QT-DE 

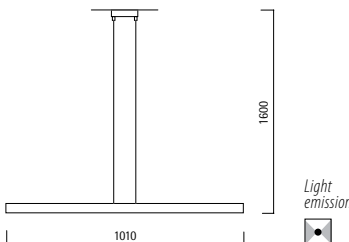

Lampada sospensione - *Pendant lamp*  
 Alluminio anodizzato - *Anodized aluminium*

**000106**

R7s 78mm 3x120W QT-DE 



Lampada da parete - *Wall lamp*  
 Alluminio anodizzato - *Anodized aluminium*

**000105**

R7s 78mm 3x120W QT-DE 







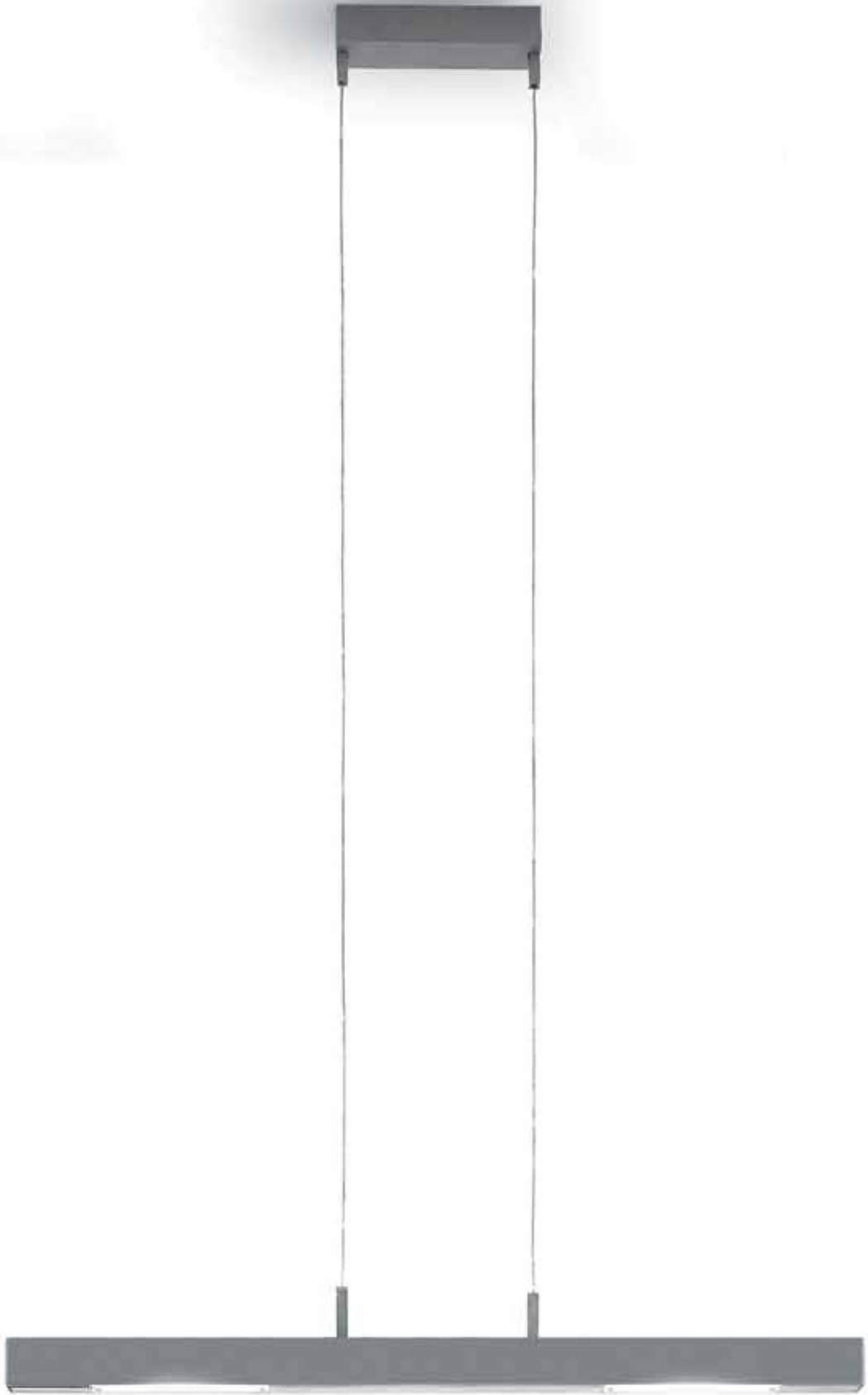

MAX



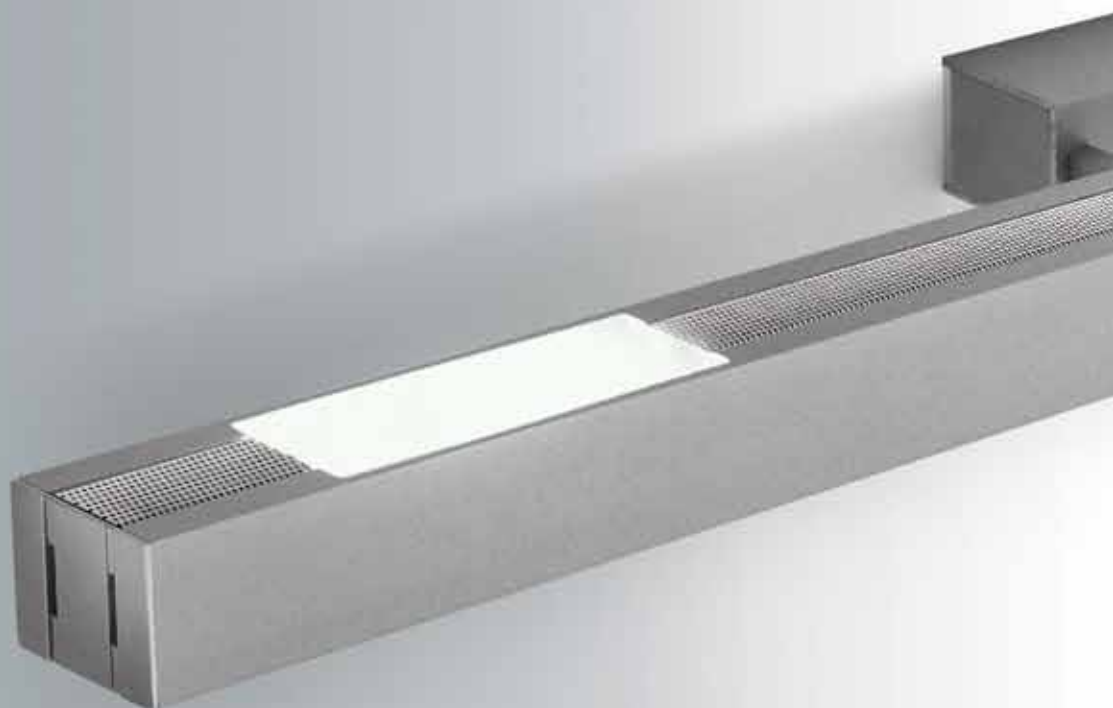

MAX

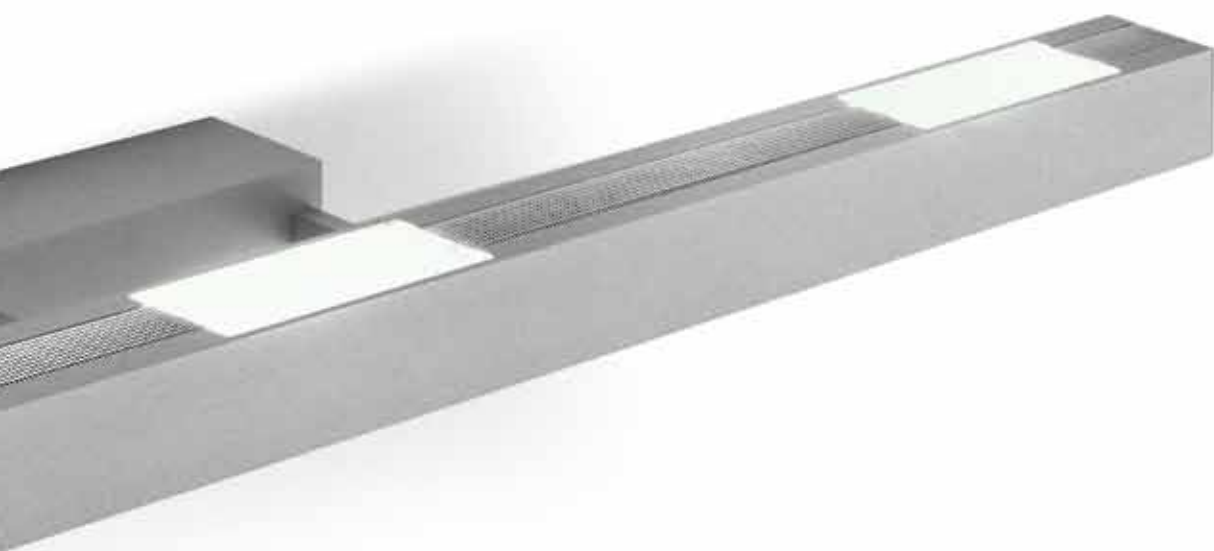

# MAX

design Roberto Favaretto

**Serie di lampade da tavolo, lettura e terra orientabili. Struttura in alluminio estruso, base in metallo verniciato. Elementi di areazione e steli cromati.**

Adjustable table, reading and floor lamps. Extruded aluminium body and painted metal base. Chrome stems and ventilation details.

Lampes de table, de lecture et de sol orientable. Structure en aluminium extrudé, base en métal laqué. Éléments d'aération et pieds chromés.

Tischleuchten, Bodenleuchten und Leseleuchten mit direktem und indirektem Licht mit doppelter Emission. Aluminium fließgepresst. Basis aus lackiertem Metall. Belüftungselemente und verchromte Schäfte.

Lámparas de mesa, de lectura y de pie orientable. Estructura de aluminio extruido, base de metal barnizado. Elementos de ventilación y astas cromados.

Корпус выполнен из штампованного алюминия. Окрашенное металлическое основание. Хромированная ножка.

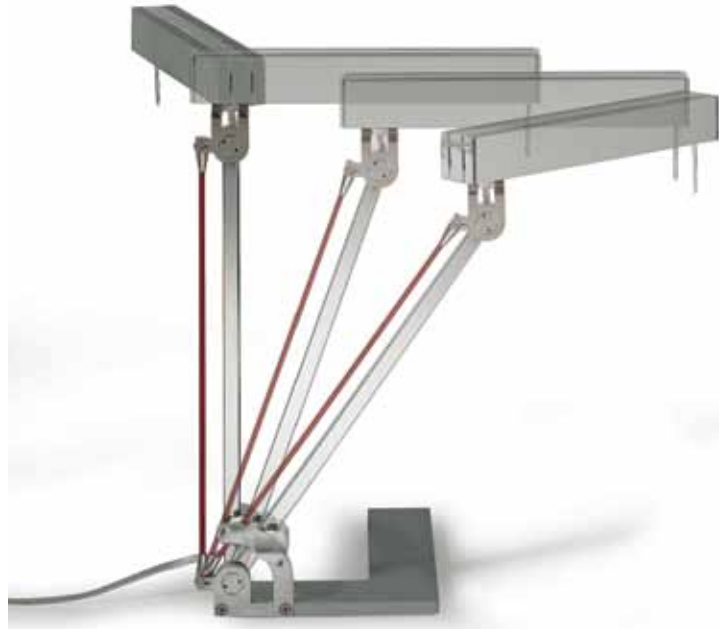

curve fotometriche disponibili photometrics available 

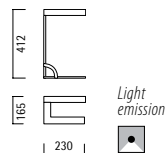

Lampada da tavolo - Table lamp  
Alluminio - Aluminium

**000114**

G9 1x60W QT-14 

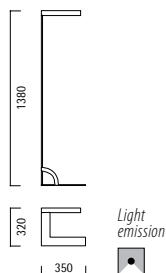

CE  IP 30 



Lampada da lettura - Reading lamp  
Alluminio - Aluminium

**000112**

G9 1x60W QT-14 

CE  IP 30 

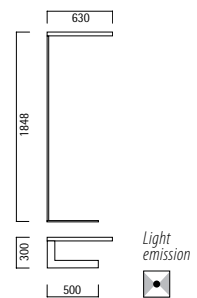

Lampada da terra - Floor lamp  
Alluminio - Aluminium

**000113**

R7s 78mm 2x120W QT-DE 

CE  IP 30 







MAX



# MAX H

design Roberto Favaretto

**Struttura in estruso di alluminio anodizzato e metallo microforato cromato.  
Giunti in policarbonato trasparente.  
Vetro di protezione in pirex satinato.**

Structure in extruded anodized aluminium and chromed micro-perforated metal.  
Clear polycarbonate joints.  
Satin pyrex seat protection glass.

Structure en extrudé d'aluminium anodisé satiné.  
Joints en polycarbonate transparent. Diffuseur supérieur en tôle micro perforée chromée.  
Verre de protection en pyrex satiné.

Struktur aus eloxiertem, satiniertem Aluminiumprofil. Verbindungen aus transparentem Polycarbonat. Oberer Lichtverteiler aus perforiertem, verchromtem Blech.  
Schutzglas aus satiniertem Pirex.

Estructura en extruso de aluminio anodizado satinado. Juntas en policarbonado transparente. Difusor superior en chapa microperforada cromada.  
Vidrio de protección en pirex satinado.

Корпус выполнен из штампованного анодированного алюминия.  
Перфорированные декоративные вставки.  
В стыковые крепления из прозрачного поликарбоната. Рассеиватели из жаростойкого стекла.

curve fotometriche disponibili photometrics available 

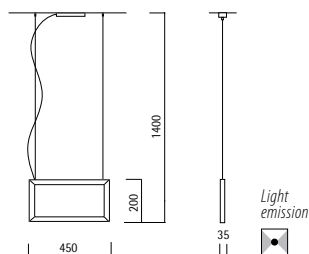

Lampada sospensione - *Pendant lamp*  
Alluminio anodizzato - *Anodized aluminium*

**013620**

R7s 78mm 1x120W QT-DE  *Sopra - Top*

R7s 78mm 1x80W QT-DE  *Sotto - Bottom*

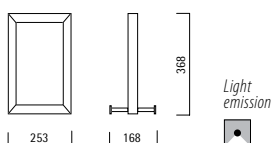

Lampada da tavolo - *Table lamp*  
Alluminio anodizzato - *Anodized aluminium*

**013605**

G9 1x60W QT-14 

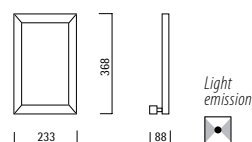

Lampada da parete - *Wall lamp*  
Alluminio anodizzato - *Anodized aluminium*

**013603**

R7s 78mm 1x80W QT-DE 

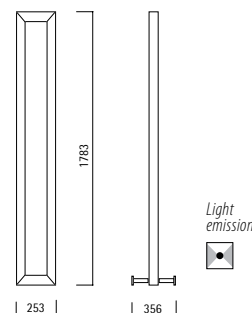

Lampada da terra - *Floor lamp*  
Alluminio anodizzato - *Anodized aluminium*

**013604**

R7s 78mm 1x120W QT-DE 



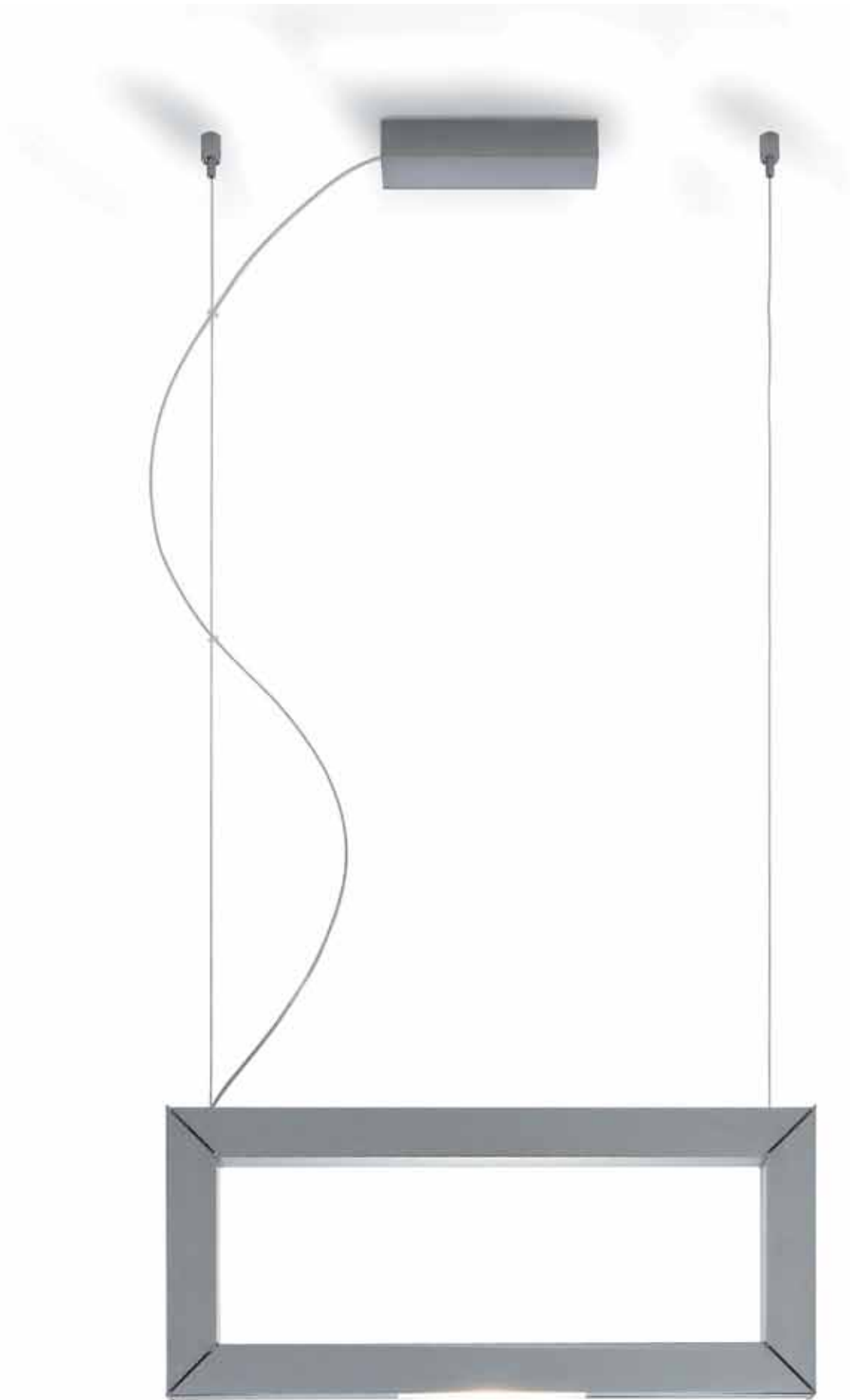



MAX H



MAX H





# TAMBURO

design Roberto Favaretto

**Struttura circolare in metallo cromato (verniciato nella versione diam. 500) con filtri colorati a scelta arancio, blu o trasparente. Diffusore in metacrilato opalino lucido. Alimentazione elettronica.**

Metal round structure, chromed for the 370 diameter lamp series and grey painted for the 500 diameter. Orange, blue and transparent filters to complete the lamp. Glossy opal acrylic diffuser. Electronic ballast.

Corps circulaire en métal chromé (laqué dans la version de diamètre 500), avec des filtres colorés orange, bleu ou transparent au choix. Diffuseur en méthacrylate opalin brillant. Ballast électronique.

Struktur des runden Lampenkörpers aus verchromten Metall (in der Ausführung mit einem Durchmesser von 500 lackiert) mit Farbfiltern in Orange, Blau bzw. transparent zur Ergänzung. Streukörper aus opalem, glänzendem Methacrylat. Elektronische Stromversorgung.

Estructura circular de metal cromado (pintado en la versión con diám. 500) completa con filtros de color anaranjado, azul o transparente. Difusor de metacrilato opalino brillo. Ballast electrónico.

Металлическое основание. Светильники диаметром 370мм выполнены в хроме. Корпус светильников диаметром 500мм окрашен в серый цвет. Фильтры на выбор оранжевого, синего или прозрачного цветов. Акриловый рассеиватель белого цвета. Регулируемая по высоте ножка потолочного светильника. Включается легким прикосновением. Электронный балласт.

curve fotometriche disponibili photometrics available 

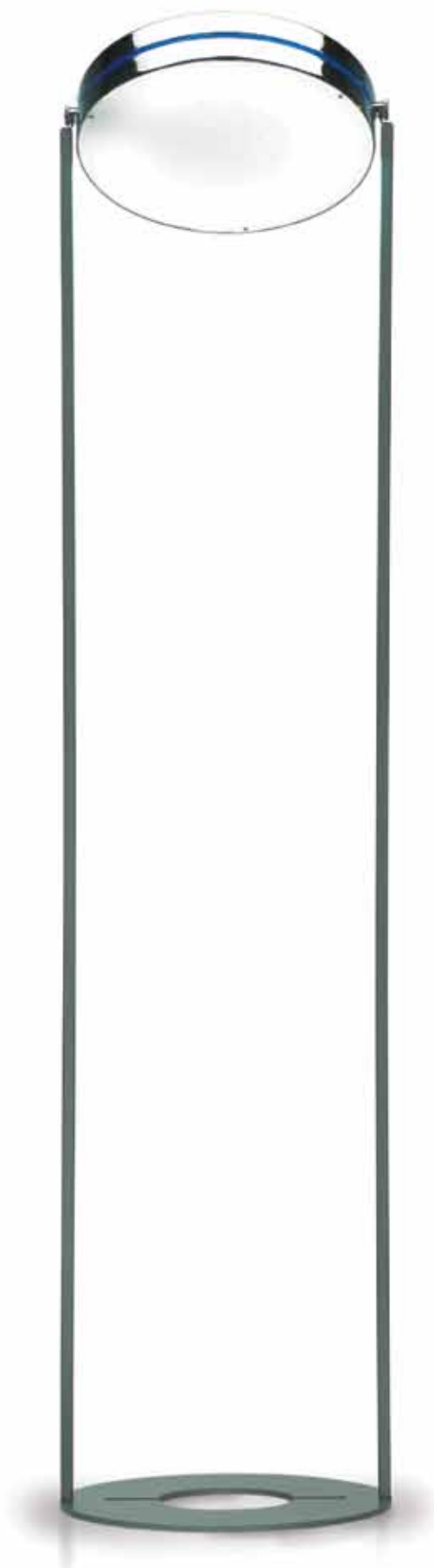

Filtro a completamento lampada  
Filter to be selected from the following options

**060045** Trasparente - Clear Ø 370  
**060044** Trasparente - Clear Ø 500

**060046** Blu - Blue Ø 370  
**060048** Blu - Blue Ø 500

**060047** Rosso - Red Ø 370  
**060043** Rosso - Red Ø 500



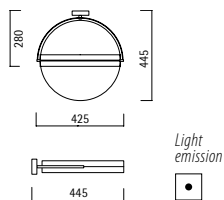
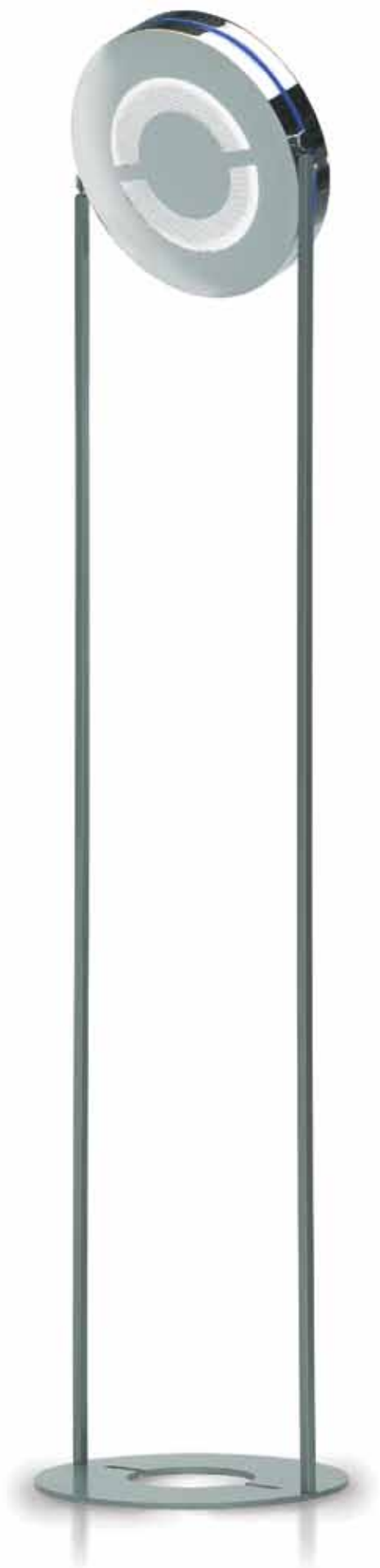

Lampada da soffitto/parete - *Ceiling/wall lamp*

**012601** Metallo cromato e verniciato  
*Chromed and painted metal*

2GX13 1x55W T5c

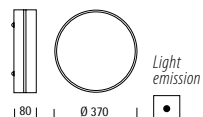

Lampada da soffitto/parete - *Ceiling/wall lamp*

**012603** Cromo - *Chrome*

2GX13 1x55W T5c

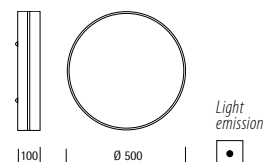

Lampada da soffitto/parete - *Ceiling/wall lamp*

**012604** Grigio argento - *Silver grey*

2GX13 40+22W T5c

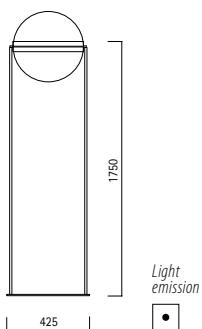

Lampada da terra - *Floor lamp*

**012607** Metallo cromato e verniciato  
*Chromed and painted metal*

2GX13 1x55W T5c

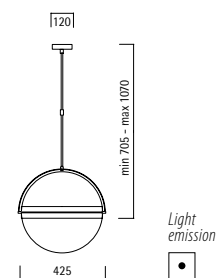

Lampada sospensione - *Pendant lamp*

**012605** Metallo cromato e verniciato  
*Chromed and painted metal*

2GX13 1x55W T5c

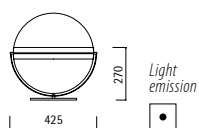

Lampada da tavolo - *Table lamp*

**012611** Metallo cromato e verniciato  
*Chromed and painted metal*

2GX13 1x55W T5c

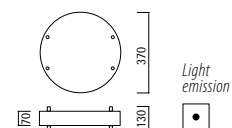

Lampada da tavolo - *Table lamp*

**012609** Metallo cromato  
*Chromed metal*

2GX13 1x55W T5c





TAMBURO





# TAMBURO



# FLAT-R

design Roberto Favaretto

**Struttura in metallo diffusore in PMMA opalino satinato, cornici disponibili in: bianco, grigio verniciato, nickel spazzolato e cromo lucido. Sospensioni a biemissione. Alimentazione elettronica.**

Metal structure, PMMA satin opal acrylic diffuser. The frames are available in white, grey, brushed nickel and polished chrome. Up-and-down light pendant. Electronic ballast.

Structure en métal, diffuseur en PMMA opalin satiné. Cadre disponibles en: blanc et gris laqué, chrome brillant et nickel brossé. Suspension avec biemission. Ballast électronique.

Struktur aus Metall, weiß PMMA diffuser. Rahmen in vier verschiedenen Ausführungen. Weiß und Grau lackiert, glänzend verchromt und Nickel gebürstet. Bi-emission pendenteuchten. Elektronische Stromversorgung.

Estructura de metal, difusor de PMMA opalino. Marcos disponibles en: blanco o gris barnizado, cromo brillo y níquel cepillado. Colgante con doble emisión. Ballast electrónico.

Металлическое основание представлено в белом, сером цветах, никеле или хrome. Электронный балласт.

curve fotometriche disponibili photometrics available 

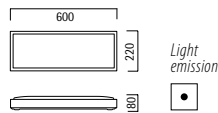

Lampada da soffitto/parete - Ceiling/wall lamp

- 007280** Bianco - White
- 007281** Grigio - Grey
- 007282** Nickel spazzolato - Brushed nickel
- 007283** Cromo - Chrome

G5 2x24W T5 

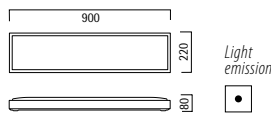

Lampada da soffitto/parete - Ceiling/wall lamp

- 007284** Bianco - White
- 007285** Grigio - Grey
- 007286** Nickel spazzolato - Brushed nickel
- 007287** Cromo - Chrome

G5 2x39W T5 

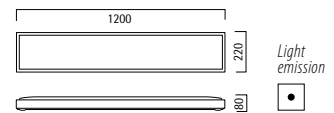

Lampada da soffitto/parete - Ceiling/wall lamp

- 007290** Bianco - White
- 007291** Grigio - Grey
- 007292** Nickel spazzolato - Brushed nickel
- 007293** Cromo - Chrome

G5 2x54W T5 

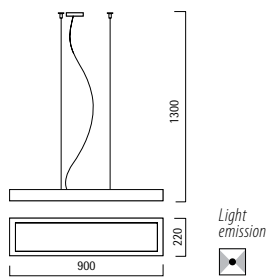

Lampada sospensione - Pendant lamp

- 007352** Bianco - White
- 007353** Grigio - Grey
- 007351** Nickel spazzolato - Brushed nickel
- 007350** Cromo - Chrome

G5 2x39W T5 

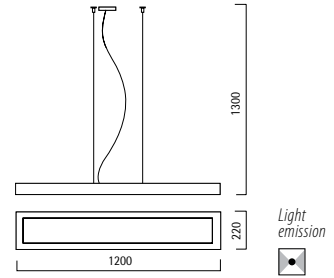

Lampada sospensione - Pendant lamp

- 007356** Bianco - White
- 007357** Grigio - Grey
- 007355** Nickel spazzolato - Brushed nickel
- 007354** Cromo - Chrome

G5 2x54W T5 



# FLAT-R







# FLAT-Q

design Roberto Favaretto

**Struttura in metallo, diffusore in PMMA opalino satinato. Cornici disponibili nelle finiture: bianco, grigio verniciato, nickel spazzolato e per le dimensioni 150x150, 300x300 e 450x450 anche in cromo lucido. Alimentazione elettronica.**

Metal structure, PMMA opal satin acrylic diffuser. The frames are available in white, grey and brushed nickel. The polished chrome option is only available for the frames sizing 150x150, 300x300 and 450x450. Electronic ballast.

Structure en métal, diffuseur en PMMA opalin satiné. Cadre disponibles en: blanc et gris laqué et nickel brossé. Cadre pour les dimensions 150x150, 300x300 et 450x450 disponible aussi chrome brillant. Ballast électronique.

Struktur aus Metall, PMMA diffuser. Rahmen in verschiedenen Ausführungen. Weiß und Grau lackiert, Nickel gebürstet. Die Rahmen 150x150, 300x300 und 450x450 sind auch in glänzend verchromt. Elektronische Stromversorgung.

Estructura de metal barnizado blanco, difusor de PMMA opalino. Marcos disponibles en: blanco o gris barnizado, níquel cepillado. Marco 150x150, 300x300 y 450x450 es disponible en cromo brillo. Ballast electrónico.

Металлическое основание представлено в белом, сером цветах, никеле или хrome. Версия 600x600мм в хrome не производится. Рассеиватель из акрила. Электронный балласт.

**La serie è disponibile nella versione in emergenza da 1H o da 3H. The range is available with emergency working 1H or 3H.**

curve fotometriche disponibili photometrics available 

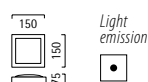

Lampada da soffitto/parete - Ceiling/wall lamp

- 007260** Bianco - White
- 007261** Grigio - Grey
- 007262** Nickel spazzolato - Brushed nickel
- 007263** Cromo - Chrome

GR10q 1x10W TC-DDE 



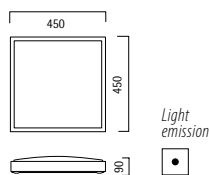

   



Lampada da soffitto/parete - Ceiling/wall lamp

- 007246** Bianco - White
- 007247** Grigio - Grey
- 007248** Nickel spazzolato - Brushed nickel
- 007249** Cromo - Chrome

2G11 3x36W TC-L 

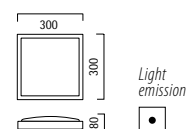

Lampada da soffitto/parete - Ceiling/wall lamp

- 007256** Bianco - White
- 007257** Grigio - Grey
- 007258** Nickel spazzolato - Brushed nickel
- 007259** Cromo - Chrome

2G11 2x18W TC-L 



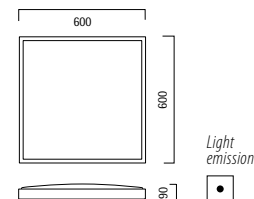

   



Lampada da soffitto/parete - Ceiling/wall lamp

- 007272** Bianco - White
- 007273** Grigio - Grey
- 007274** Nickel spazzolato - Brushed nickel

2G11 3x55W TC-L 

**Bianco**  
White



**Grigio**  
Grey



**Cromo**  
Chrome



**Nickel spazzolato**  
Brushed nickel

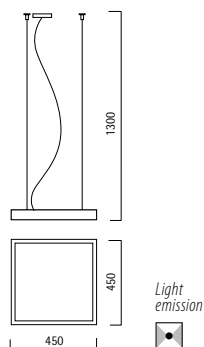

Lampada sospensione - Pendant lamp

- 007362** Bianco - White
- 007363** Grigio - Grey
- 007361** Nickel spazzolato - Brushed nickel
- 007360** Cromo - Chrome

2G11 3x36W TC-L 

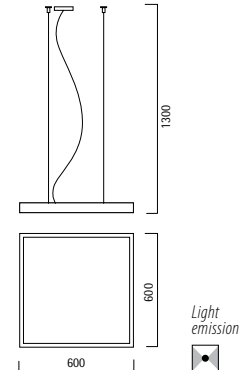

Lampada sospensione - Pendant lamp

- 007366** Bianco - White
- 007367** Grigio - Grey
- 007365** Nickel spazzolato - Brushed nickel

2G11 3x55W TC-L 

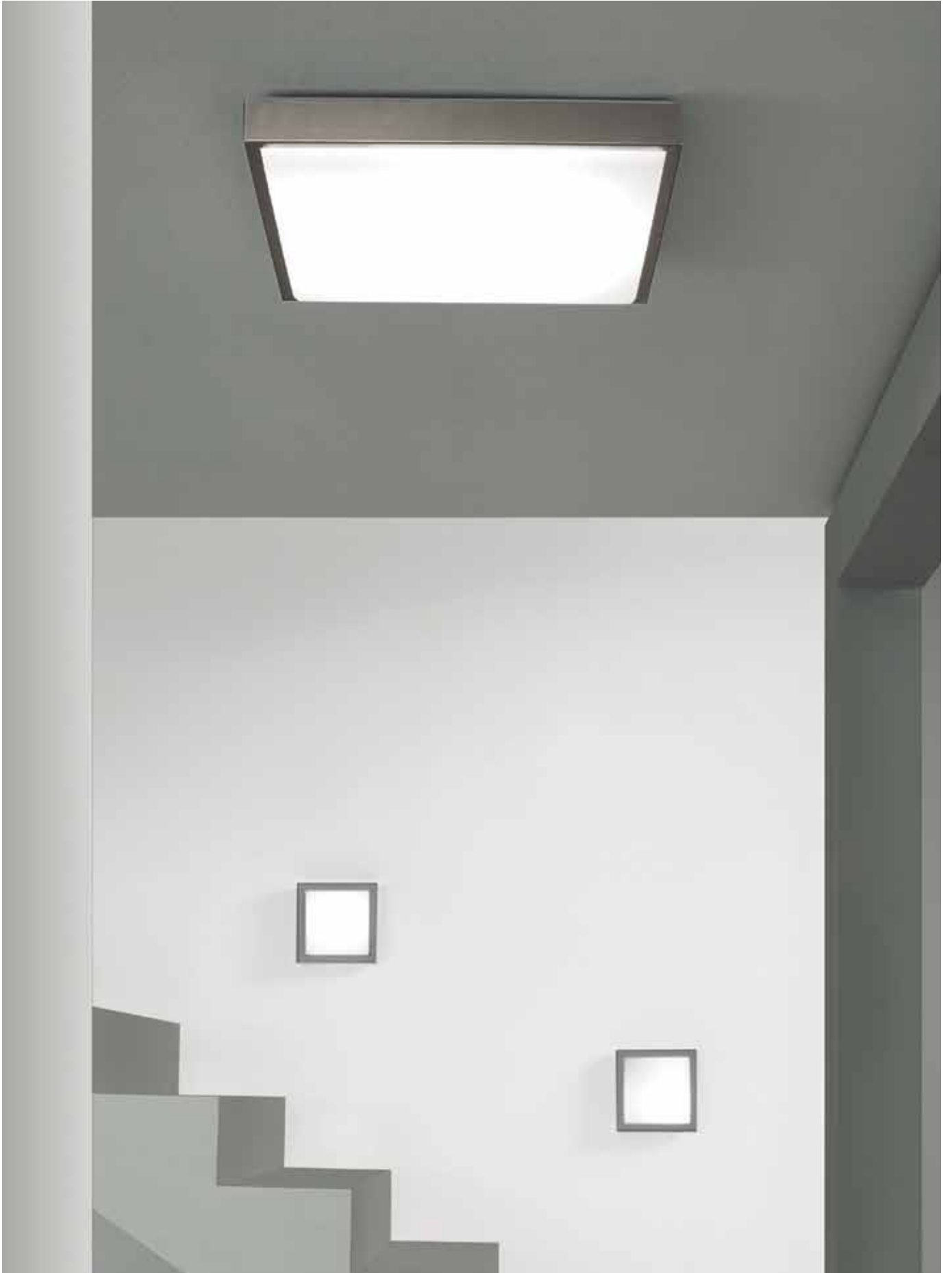

# FLAT-Q



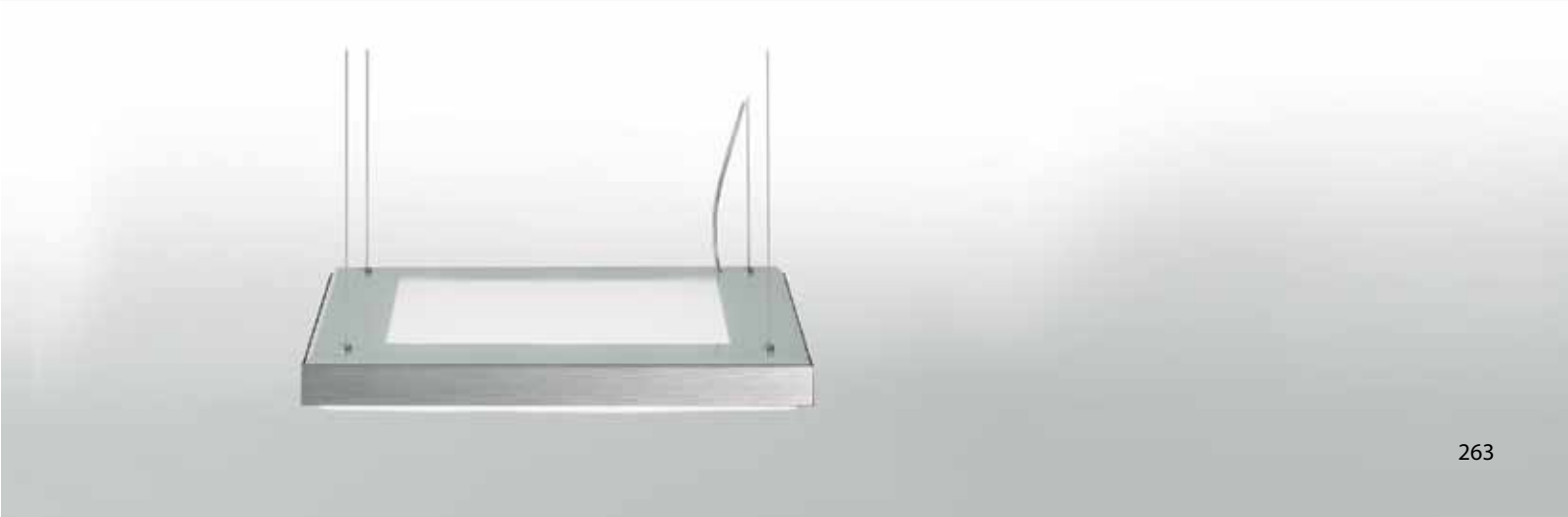

# AGAVE

design Roberto Favaretto

## Diffusore opale e trasparente in vetro soffiato. Struttura in metallo cromato.

Opal and transparent blown glass diffuser.  
Chrome metal structure.

Diffuseur opale et transparent en verre soufflé.  
Structure en métal chromé.

Gebblasenem opal und transparentem Glas.  
Struktur aus verchromtem Metall.

Difusor opal y transparente en vidrio soplado.  
Estructura en metal cromado.

Плафоны из дутого стекла.  
Хромированное металлическое основание.

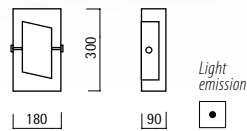

Lampada da parete - Wall lamp  
Vetro opale - Opal glass

**013103**

R7s 78mm 1x80W QT-DE

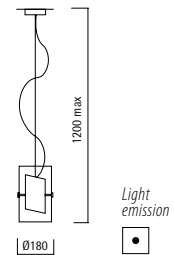

Lampada sospensione - Pendant lamp  
Vetro opale - Opal glass

**013112**

E27 1x70W A55

E27 1x14W TC-TSE

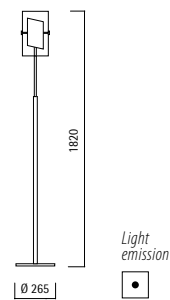

Lampada da terra - Floor lamp  
Vetro opale - Opal glass

**013162**

E27 1x205W QT-32

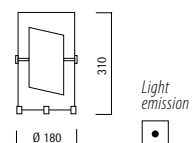

Lampada da tavolo - Table lamp  
Vetro opale - Opal glass

**013011**

E27 1x70W A55

E27 1x14W TC-TSE









**Diffusore in ceramica bone china bianca con texture a rilievo. Struttura in pressofusione verniciata grigia.**

White bone china lamp with relief texture.  
Grey painted metal structure.

Diffuseur en porcelaine tendre blanche avec texture en relief. Structure en zamak moulé sous pression laquée grise.

Licht aus weißem Bone China Porzellan mit Relieftextur. Struktur aus Druckguss-Zamak, grau lackierte.

Difusor de cerámica bone china blanca, con textura en relieve. Estructura de zamak fundido en presión, barnizada gris.

Рельефный плафон из фарфора.  
Металлическое основание

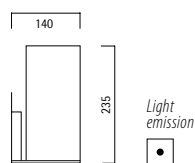

Lampada da parete - *Wall lamp*  
Diffusore ceramica bone china bianca  
*White bone china diffuser*

**014050**

E27 1x70W A55   
E27 1x21W TC-TSE 

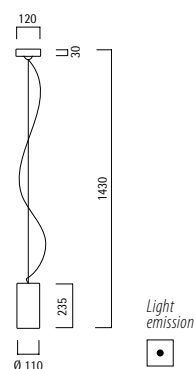

Lampada sospensione - *Pendant lamp*  
Diffusore ceramica bone china bianca  
*White bone china diffuser*

**014051**

E27 1x52W A55   
E27 1x21W TC-TSE 

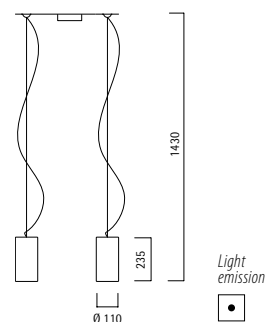

Lampada sospensione - *Pendant lamp*  
Diffusore ceramica bone china bianca  
*White bone china diffuser*

**014052**

E27 2x52W A55   
E27 2x21W TC-TSE 

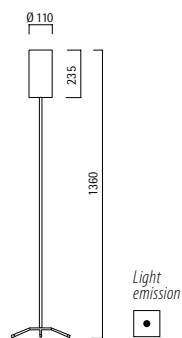

Lampada da terra - *Floor lamp*  
Diffusore ceramica bone china bianca  
*White bone china diffuser*

**014053**

E27 1x70W A55   
E27 1x21W TC-TSE 

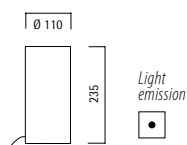
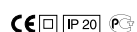

Lampada da tavolo - *Table lamp*  
Diffusore ceramica bone china bianca  
*White bone china diffuser*

**014054**

E27 1x70W A55   
E27 1x21W TC-TSE 













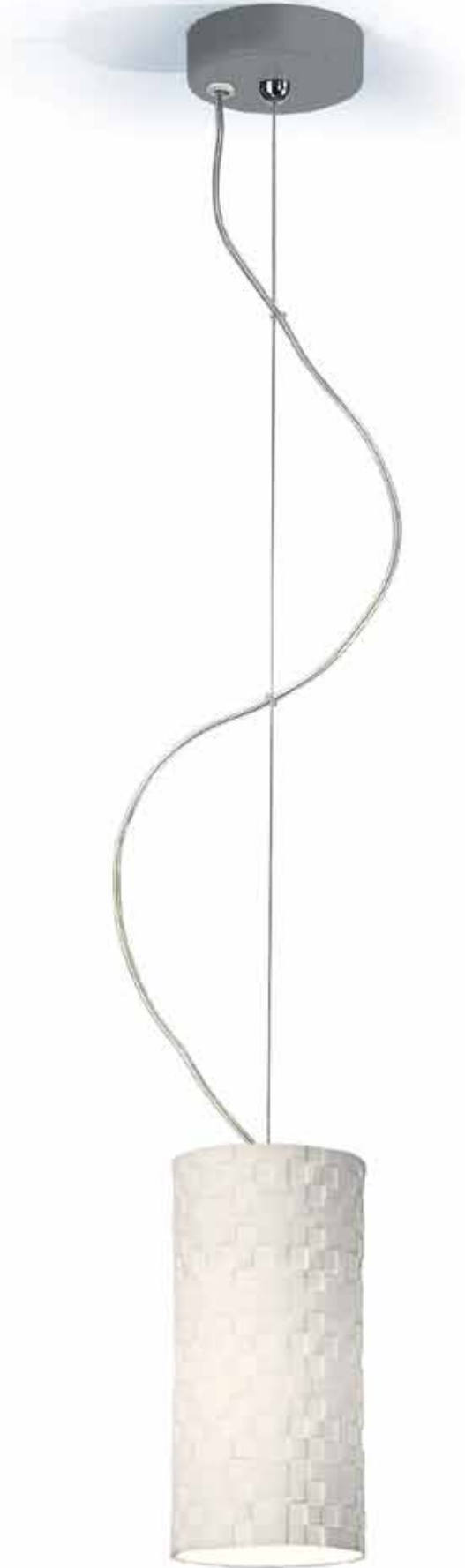



















NIPPO





**Lampade fluorescenti** - Fluorescent lamps

Symbol	Uni	Wattage	Socket	Code
	TC-S	9W	G23	<b>052564</b>
	TC-SE	11W	2G7	<b>052559</b>
	TC-D	13W	G24d-1	<b>052560</b>
	TC-D	18W	G24d-2	<b>052569</b>
	TC-D	26W	G24d-3	<b>052562</b>
	TC-DE	18W	G24q-2	<b>052563</b>
	TC-DE	26W	G24q-3	<b>052565</b>
	TC-DD	16W	GR8	<b>052561</b>
	TC-DD	28W	GR8	<b>052566</b>
	TC-DDE	10W	GR10q	<b>052570</b>
	TC-DDE	28W	GR10q	<b>052567</b>
	TC-DDE	38W	GR10q	<b>052568</b>
	TC-L	18W	2G11	<b>052622</b>
	TC-L	24W	2G11	<b>052621</b>
	TC-L	36W	2G11	<b>052624</b>
	TC-L	55W	2G11	<b>052650</b>
	TC-F	24W	2G10	<b>052604</b>
	TC-F	36W	2G10	<b>052608</b>
	TC-TSE	14W	E27	<b>052630</b>
	TC-TSE	17W	E27	<b>052528</b>
	TC-TSE	21W	E27	<b>052648</b>
	TC-TSE	24W	E27	<b>052638</b>
	TC-TSE	30W	E27	<b>052668</b>
	T16 (T5)	24W	G5	<b>052625</b>
	T16 (T5)	28W	G5	<b>052667</b>
	T16 (T5)	39W	G5	<b>052623</b>
	T16 (T5)	54W	G5	<b>052649</b>
	T5c	22W	2GX13	<b>052639</b>
	T5c	40W	2GX13	<b>052641</b>
	T5c	55W	2GX13	<b>052640</b>
	T-R	22W	G10q	<b>052642</b>
	T-R	32W	G10q	<b>052644</b>
	MICROLYNX_F	7W	GX53	<b>052647</b>
	MICROLYNX_F	9W	GX53	<b>052662</b>

**Lampade alogene** - Halogen lamps

Symbol	Uni	Wattage	Socket	Code
	QT-13	20W	G9	<b>052532</b>
	QT-13	33W	G9	<b>052535</b>
	QT-13	48W	G9	<b>052540</b>
	QT-14	60W	G9	<b>052531</b>
	QT-DE 78mm	80W	R7s	<b>052533</b>
	QT-DE 78mm	120W	R7s	<b>052534</b>
	QT-DE 118mm	120W	R7s	<b>052536</b>
	QT-DE 118mm	160W	R7s	<b>052521</b>
	QT-DE 118mm	230W	R7s	<b>052522</b>
	QPAR	50W	GU10	<b>052530</b>
	QPAR	75W	GU10	<b>052527</b>
	QT-32	70W	E27	<b>052636</b>
	QT-32	100W	E27	<b>052637</b>
	QT-32	205W	E27	<b>052663</b>

**Lampade ad incandescenza** - incandescent lamps

Symbol	Uni	Wattage	Socket	Code
	A55	28W	E27	<b>052665</b>
	A55	42W	E27	<b>052611</b>
	A55	52W	E27	<b>052612</b>
	A55	70W	E27	<b>052602</b>
	A55	105W	E27	<b>052666</b>
	B35	28W	E14	<b>052664</b>
	P45	28W	E14	<b>052609</b>
	P45	42W	E14	<b>052613</b>

Tutti i prodotti di GRUPPO ROSTIROLLA s.r.l. che rientrano nell'ambito di applicazione della direttiva europea EMC 89/336 e 93/68 EEC, soddisfano i requisiti richiesti e recano la marcatura **CE**. Il simbolo **CE** è posto sull'imballo del prodotto.

Nella continua ricerca di miglioramenti tecnici e funzionali, GRUPPO ROSTIROLLA s.r.l. si riserva il diritto di apportare modifiche anche sostanziali ai propri prodotti, che potranno essere effettuate senza preavviso. Disegni, quote e colori sono da intendersi a titolo puramente indicativo e non sono impegnative per GRUPPO ROSTIROLLA s.r.l.

All the products of GRUPPO ROSTIROLLA s.r.l. meet with current European directives EMEC 89/336 and 93/68 EEC, meet their requirements and are **CE** marked. The symbol **CE** is placed on the packaging of the product.

In accordance with its policy of continuous products development GRUPPO ROSTIROLLA s.r.l. reserves the right to modify its products without prior notice. Descriptions, charges and colours in this catalogue are indicative.

### Degree of ingress protection

**IP20:** Protezione contro l'ingresso di corpi solidi  $\varnothing \geq 12\text{mm}$   
Protected against the penetration of solid bodies  $\varnothing \geq 12\text{mm}$

**IP30:** Protezione contro l'ingresso di corpi solidi  $\varnothing \geq 2,5\text{ mm}$   
Protected against the penetration of solid bodies  $\varnothing \geq 2,5\text{mm}$

**IP40:** Protezione contro l'ingresso di corpi solidi  $\varnothing \geq 1\text{mm}$   
Protected against the penetration of solid bodies  $\varnothing \geq 1\text{mm}$

**IP44:** Protezione contro l'ingresso di corpi solidi  $\varnothing \geq 1\text{mm}$   
e contro gli spruzzi  
Protected against the penetration of solid bodies  $\varnothing \geq 1\text{mm}$   
and against the squeezes

### Light emission



Diffondente  
Diffused



Diretta  
Direct



Indiretta  
Indirect



Diretta e indiretta  
Direct and indirect



Orientabile  
Adjustable

### Approvals



Certificazione di conformità europea  
Certification of European conformity



Apparecchio idoneo al montaggio su superfici infiammabili  
Luminaire suitable for installation on inflammable surfaces



GOST  
Certificazione di conformità valida per la Federazione Russa  
Certification for Russian Federation

### Class



Classe I - Class I - Classe I - Klasse I - Clase I

Apparecchio nel quale la sicurezza elettrica è garantita da un conduttore supplementare di protezione (messa a terra) collegato alla struttura metallica della lampada.

A light fitting whose safety is guaranteed by an additional protective conductor (earth) connected with the metal frame of the lamp.



Classe II - Class II - Classe II - Klasse II - Clase II

Apparecchio nel quale la protezione contro la scossa elettrica si basa unicamente sul doppio isolamento e/o isolamento rinforzato in ogni parte e senza dispositivo di messa a terra.

Light fittings whose safety is guaranteed by the double reinforced insulation of conductive parts, with no earth.

## Direttiva RAEE: Rifiuti di Apparecchiature Elettriche ed Elettroniche

Il 25 Luglio 2005 il Consiglio dei Ministri ha recepito con Decreto Legislativo no 151 la Direttiva Europea 2002/95/CE e 2002/96/CE relativa alla riduzione delle sostanze pericolose nelle apparecchiature elettriche ed elettroniche e dello smaltimento dei rifiuti da essi derivanti. L'obiettivo è promuovere una logica di sviluppo sostenibile nel settore delle apparecchiature elettriche ed elettroniche, di cui gli apparecchi di illuminazione ne fanno parte, ai fini di un corretto trattamento dei prodotti a fine vita e ciò può attuarsi attraverso la piena conformità alla Direttiva RAEE. Il Produttore, come definito dal Dlgs no 151, dovrà farsi carico dei costi di gestione che comprendono la raccolta, presso gli impianti di stoccaggio provvisorio e dello smaltimento dei rifiuti degli apparecchi di illuminazione immessi sul mercato dopo l'Agosto 2006. Per adempiere a questi obblighi di legge LUCENTE S.r.l. ha deciso di avvalersi del supporto del Consorzio ECOLIGHT, Via Gattamelata 34, 20149 Milano Tel 02 33600732.



Gli apparecchi di illuminazione saranno marcati in modo da identificare il Produttore e riportare il simbolo del cassonetto barrato, indicante la raccolta differenziata separata dal resto dei rifiuti urbani, inoltre saranno soggetti al contributo di smaltimento, differenziato per fascia di peso. Gli utenti finali potranno consegnare i suddetti apparecchi senza costi aggiuntivi presso i punti di raccolta appositamente realizzati e comunicati dal Consorzio. I distributori sono obbligati ad assicurare al momento della fornitura di una nuova apparecchiatura, il ritiro gratuito, in ragione di uno ad uno, della apparecchiatura usata. L'obbligo di informazione relativo al contributo dovrà essere mantenuto visibile in fattura, da parte del Produttore, fino al 13 febbraio 2011.

I prodotti elencati con il relativo peso netto alla fine del presente catalogo saranno soggetti al contributo di smaltimento a seconda della fascia di peso di appartenenza:

- fascia 1: apparecchi il cui peso è compreso tra 0 e 2 Kg
- fascia 2: apparecchi il cui peso è compreso tra 2 e 8 Kg
- fascia 3: apparecchi il cui peso è superiore a 8 Kg

### Direttiva RoHS

Il Decreto Legislativo sopra menzionato incorpora anche la Direttiva 2002/95/CE - RoHS - Limiti d'uso di alcune sostanze pericolose - relativa alla riduzione delle sostanze pericolose nelle apparecchiature elettriche ed elettroniche.

A partire dal 1° Luglio 2006 tutte le nuove apparecchiature elettriche ed elettroniche immesse sul mercato non dovranno contenere o contenere in misura limitata sostanze quali: Piombo, Mercurio, Cadmio, Cromo esavalente, Bifenile polibromurati (PBB), Eteri difendi polibromurati (PBDE).

## WEEE Directive: Waste Electrical and Electronic Equipment

On the 25th July 2005, the Council of Ministers incorporated the European Directive 2002/95/CE and 2002/96/CE – related to the reduction of hazardous substances in electronic and electrical equipment and their waste disposal - into Italian legislation with the Legislative Decree number 151. The objective is that of promoting a notion of sustainable development within the electronic and electrical equipment sector, to which lighting equipment belongs, with the aim of correctly treating the products once they have reached the end of their lives; this may be accomplished by fully complying with the WEEE Directive. The Manufacturer, as defined by the Legislative Decree number 151, will be responsible for the management costs which include collection from temporary storage facilities and the costs for waste disposal of the lighting Equipment. In order to fulfil these legal obligations LUCENTE S.r.l. have decided to call upon the support of the ECOLIGHT Consortium; Consorzio ECOLIGHT, Via Gattamelata 34, 20149 Milan Tel. +39 02 3360 0732.



The lighting equipment will be marked in such a way as to identify the Manufacturer and show the symbol of the crossed wheeled bin, which indicates a separate collection from the rest of the urban waste, the equipment will also be subject to a disposal contribution and will be distinguishable by its weight range. The contribution will be determined prior to the law coming into force and will be made official by the ECOLIGHT Consortium. The end users will be able to deliver the above-mentioned equipment without any add-on costs to the authorised collection sites as notified by the Consortium. Distributors are obliged to ensure a free take-back service of the used equipment, at the time of the supply of a new unit, on a one-to-one basis. The Manufacturer has a duty to supply and maintain information related to the amount of contribution and this must be shown on invoices until 13th February 2011.

The products listed in this catalogue will be marked with range symbols. Each symbol should be shown against its relevant range within the following table and each range will be subject to a different disposal contribution:

- range 1: the equipment weight which is between 0 and 2 kg
- range 2: the equipment weight which is between 2 up to 8kg
- range 3: the equipment weight which is over 8kg

### The RoHS Directive

The above-mentioned Legislative Decree has also implemented the RoHS 2002/95/CE Directive. The Restriction of the use of certain Hazardous Substances (RoHS) in electrical and electronic equipment.

As from 1st July 2006, all new electrical and electronic equipment put on the market must not contain, or contain limited quantities of, certain substance, namely: Lead, Mercury, Cadmium, Hexavalent chromium, Polybromide biphenyls (PBBs), Polybromide diphenyl ethers (PBDEs).

---

## Edizione giugno 2013

Concept and graphic design: Anna Silvestrini

Print: Grafiche Gemma

Edition 2013

Photography: Daniele Di Pietro

Stylist: Sara Sarli

Images retouching: Simone Marcuzzo

Thanks to:

FLOORCOVERING by Dal Santo Flavio, MARSURA SALVINO SCULTORE, TIVOLI AUDIO



LUCENTE®

is a brand of  
GRUPPO ROSTIROLLA Srl

Via Piemonte 1/A  
31038 Padernello di Paese  
Treviso - Italy

Tel. +39 0422 4575  
Fax +39 0422 950720

[info@lucente.eu](mailto:info@lucente.eu)  
[www.lucente.eu](http://www.lucente.eu)